



# Mbs-signsupply.com



*Milano*  
Digital Papers & Films

**RECEIVE IN 1-3 DAYS AT YOUR DOOR!**

**FROM TAMPA**

We Ship The Orders Same-Day to 48 States

TAMPA | CHICAGO | DENVER | LAS VEGAS

**Wholesale**  
Vinyl, Medias, Papers, Inks,  
Signs, Lights, Standoffs, Tools,  
Hardware And More...

CALL US +1 (303) 935-8565

# We Ship The Orders Same-Day and Receive in 1-3 Days at your door!



**Mbs-Standoffs & Mbs-Signsupply**  
Headquarters  
TAMPA



**Mbs-Standoffs & Mbs-Signsupply**  
CHICAGO



**Mbs-Standoffs & Mbs-Signsupply**  
Milano  
DENVER



**Mbs-Standoffs & Mbs-Signsupply**  
LAS VEGAS



**Monday–Thursday**  
Up to 6:30 PM (EST)  
**Friday**  
Up to 5:30 PM

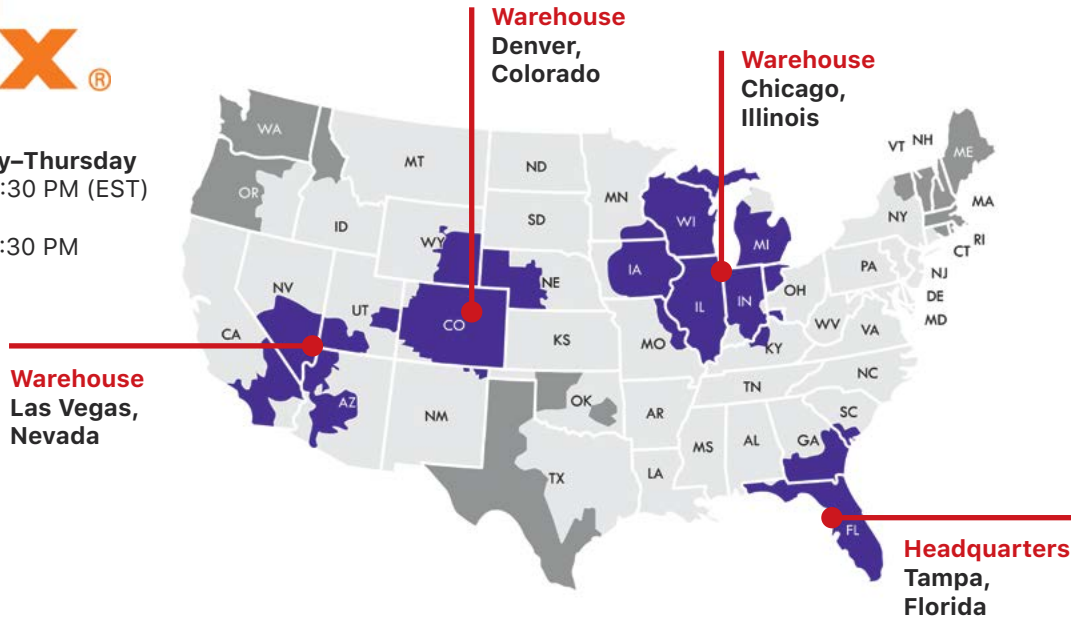

- 1  
Receive in  
1 Day
- 2  
Receive in  
2 Days
- 3  
Receive in  
3 Days

## DAILY PICK-UPS



We have a daily pick-up, so that all of our customers can take advantage of same day shipping.



Blind Shipping & Drop Shipping Available Upon Request (Fees may apply).



Don't forget we can always ship on your account.



If you are local, you can pick up your order within 30 minutes of placing your order.



Monday–Thursday up to 6:30 PM (EST)  
Friday up to 5:30 PM



Anywhere in the world with DHL

For more information, call +1 (303) 935-8565 or See our website [mbs-signsupply.com](http://mbs-signsupply.com)

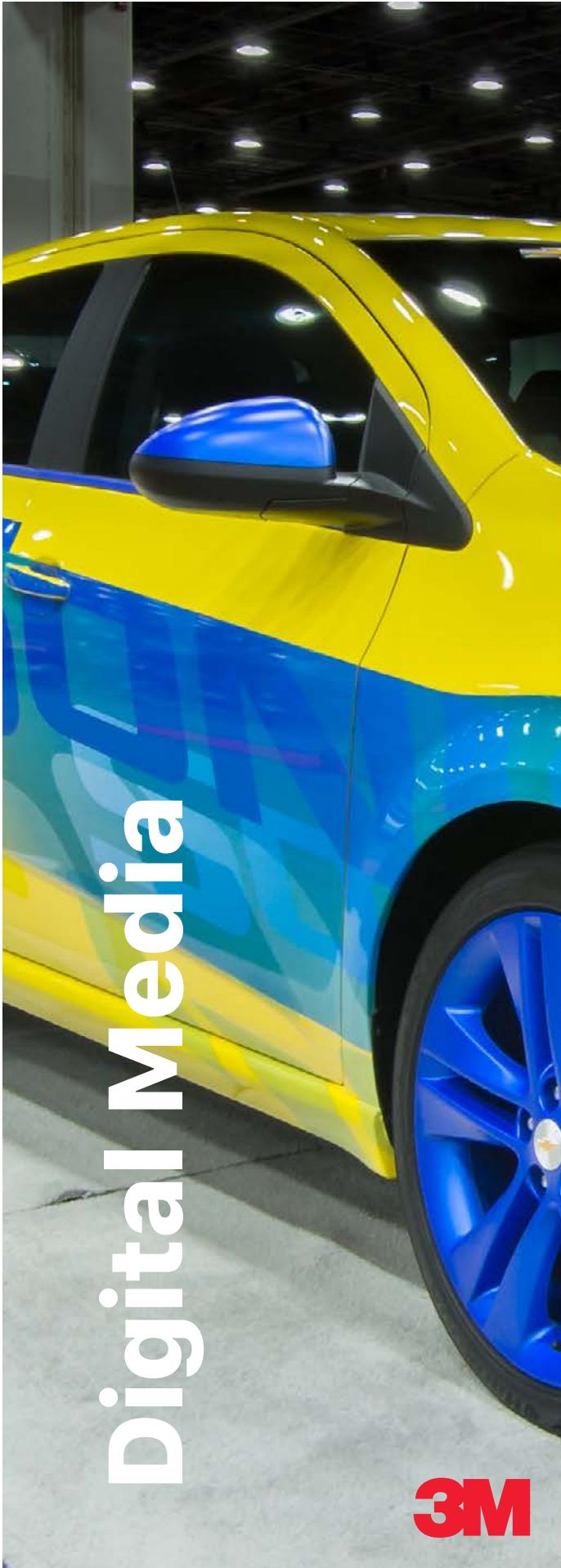

# Digital Media



## **PRINTABLE VINYL**

|                      |    |
|----------------------|----|
| 3M                   | 4  |
| Avery Dennison       | 6  |
| General Formulations | 8  |
| KONG                 | 10 |

## **OVERLAMINATE FILMS**

|                      |    |
|----------------------|----|
| 3M                   | 12 |
| Avery Dennison       | 13 |
| General Formulations | 14 |
| KONG                 | 15 |

## **BANNERS**

|      |    |
|------|----|
| KONG | 16 |
|------|----|

## **BANNER FILMS**

|      |    |
|------|----|
| KONG | 17 |
|------|----|

## **CANVAS**

|      |    |
|------|----|
| KONG | 18 |
|------|----|

## **MOUNTING ADHESIVES**

|                      |    |
|----------------------|----|
| General Formulations | 19 |
| KONG                 | 19 |

## **ART & PHOTO PAPERS**

|                |    |
|----------------|----|
| Avery Dennison | 20 |
|----------------|----|

## **WINDOW FILMS**

|                      |    |
|----------------------|----|
| Avery Dennison       | 21 |
| General Formulations | 21 |

## **ONE-WAY VISION PERFORATED FILMS**

|                      |    |
|----------------------|----|
| 3M                   | 22 |
| Avery Dennison       | 22 |
| Continental Grafix   | 23 |
| General Formulations | 23 |

## **INKS**

|        |    |
|--------|----|
| Milano | 24 |
|--------|----|

PRINTABLE VINYL



Outdoor, Vehicle / Fleet & Transit Graphic Films



| Key Features |                 |             |                   |           | Application Areas |               |                  |               |         | Available Sizes |                |             |             |              |              |              |             |             |              |              |              |             |             | Item #       |              |              |             |             |             |              |              |              |             |             |              |              |              |   |      |          |          |        |        |  |  |  |  |  |  |  |
|--------------|-----------------|-------------|-------------------|-----------|-------------------|---------------|------------------|---------------|---------|-----------------|----------------|-------------|-------------|--------------|--------------|--------------|-------------|-------------|--------------|--------------|--------------|-------------|-------------|--------------|--------------|--------------|-------------|-------------|-------------|--------------|--------------|--------------|-------------|-------------|--------------|--------------|--------------|---|------|----------|----------|--------|--------|--|--|--|--|--|--|--|
| Film Type    | Thickness (mil) | Face Finish | Durability (year) | Adhesive  | Vehicle Wraps     | Outdoor Signs | POP / Trade Show | Backlit Signs | Windows | Walls           | Floor Graphics | 25" x 25 yd | 30" x 50 yd | 30" x 100 yd | 30" x 150 yd | 30" x 200 yd | 36" x 10 yd | 36" x 50 yd | 36" x 100 yd | 36" x 150 yd | 36" x 200 yd | 48" x 25 yd | 48" x 50 yd | 48" x 100 yd | 48" x 150 yd | 48" x 200 yd | 54" x 10 yd | 54" x 25 yd | 54" x 50 yd | 54" x 100 yd | 54" x 150 yd | 54" x 200 yd | 60" x 25 yd | 60" x 50 yd | 60" x 100 yd | 60" x 150 yd | 60" x 200 yd |   |      |          |          |        |        |  |  |  |  |  |  |  |
| Cast         | 2               | Matte       | 3                 | Removable |                   |               |                  |               |         |                 | •              |             |             |              |              |              |             |             |              |              |              | ✓           | ✓           |              |              |              |             |             |             |              |              |              |             |             |              |              |              |   | 3662 |          |          |        |        |  |  |  |  |  |  |  |
| Cast         | 3.5             | Matte       | 5                 | Permanent | •                 | •             |                  |               |         | •               |                |             |             |              |              |              |             |             |              |              |              |             |             |              |              |              |             |             | ✓           | ✓            |              |              |             |             | ✓            | ✓            |              |   |      | IJ39     |          |        |        |  |  |  |  |  |  |  |
| Cast         | 2               | Luster      | 10                | Removable | •                 | •             | •                |               | •       | •               |                |             |             |              |              |              |             |             |              |              |              |             |             |              |              |              |             |             | ✓           | ✓            |              |              |             |             |              |              |              |   |      | IJ170Cv3 |          |        |        |  |  |  |  |  |  |  |
| Cast         | 2               | Luster      | 10                | Removable | •                 |               |                  |               |         |                 |                | ✓           | ✓           | ✓            | ✓            |              | ✓           | ✓           | ✓            | ✓            | ✓            | ✓           | ✓           | ✓            | ✓            | ✓            | ✓           | ✓           | ✓           | ✓            | ✓            | ✓            | ✓           | ✓           | ✓            | ✓            | ✓            | ✓ | ✓    | ✓        | IJ180-10 |        |        |  |  |  |  |  |  |  |
| Cast         | 2               | Gloss       | 8                 | Removable | •                 | •             | •                |               | •       |                 |                | ✓           | ✓           | ✓            | ✓            |              | ✓           | ✓           | ✓            | ✓            | ✓            | ✓           | ✓           | ✓            | ✓            | ✓            | ✓           | ✓           | ✓           | ✓            | ✓            | ✓            | ✓           | ✓           | ✓            | ✓            | ✓            | ✓ | ✓    | ✓        | IJ180C   |        |        |  |  |  |  |  |  |  |
| Cast         | 2               | White       | 3                 | Removable | •                 | •             |                  |               | •       |                 |                | ✓           | ✓           |              |              |              |             | ✓           | ✓            |              |              |             | ✓           | ✓            | ✓            |              |             |             | ✓           | ✓            | ✓            | ✓            | ✓           | ✓           | ✓            | ✓            | ✓            | ✓ | ✓    | IJ180mC  |          |        |        |  |  |  |  |  |  |  |
|              |                 | Transparent |                   |           |                   |               |                  |               |         |                 |                |             |             |              |              |              |             |             |              |              |              |             |             |              |              |              |             |             |             |              |              |              |             |             |              |              |              |   |      |          |          |        |        |  |  |  |  |  |  |  |
|              |                 | Metallic    |                   |           |                   |               |                  |               |         |                 |                |             |             |              |              |              |             |             |              |              |              |             |             |              |              |              |             |             |             |              |              |              |             |             |              |              |              |   |      |          |          |        |        |  |  |  |  |  |  |  |
|              |                 | White       |                   |           |                   |               |                  |               |         |                 |                |             |             |              |              |              |             |             |              |              |              |             |             |              |              |              |             |             |             |              |              |              |             |             |              |              |              |   |      |          |          |        |        |  |  |  |  |  |  |  |
|              |                 | Luster      |                   |           |                   |               |                  |               |         |                 |                |             |             |              |              |              |             |             |              |              |              |             |             |              |              |              |             |             |             |              |              |              |             |             |              |              |              |   |      |          |          |        |        |  |  |  |  |  |  |  |
| Cast         | 2               | Gloss       | 8                 | Removable | •                 | •             | •                |               | •       |                 |                | ✓           | ✓           | ✓            | ✓            |              | ✓           | ✓           | ✓            | ✓            | ✓            | ✓           | ✓           | ✓            | ✓            | ✓            | ✓           | ✓           | ✓           | ✓            | ✓            | ✓            | ✓           | ✓           | ✓            | ✓            | ✓            | ✓ | ✓    | ✓        | IJ180Cv3 |        |        |  |  |  |  |  |  |  |
| Cast         | 2               | Luster      | 2                 | Removable | •                 | •             | •                |               | •       | •               |                |             |             |              |              |              |             |             |              |              |              |             | ✓           | ✓            | ✓            |              |             |             | ✓           | ✓            | ✓            | ✓            | ✓           | ✓           | ✓            | ✓            | ✓            | ✓ | ✓    | IJ3552C  |          |        |        |  |  |  |  |  |  |  |
| Cast         | 2               | Luster      | 10                | Removable | •                 |               |                  |               |         |                 |                |             |             |              |              |              |             |             |              |              |              |             |             |              |              |              |             | ✓           | ✓           |              |              |              |             |             |              |              |              |   |      | IJ380Cv3 |          |        |        |  |  |  |  |  |  |  |
| Cast         | 2               | Matte       | 7                 | Permanent |                   |               |                  |               | •       | •               |                |             |             |              |              |              |             |             |              |              |              | ✓           | ✓           | ✓            | ✓            | ✓            | ✓           | ✓           | ✓           | ✓            | ✓            | ✓            | ✓           | ✓           | ✓            | ✓            | ✓            | ✓ | ✓    | IJ3630   |          |        |        |  |  |  |  |  |  |  |
| Cast         | 2               | Clear       | 10                | Permanent | •                 | •             | •                | •             | •       |                 |                | ✓           | ✓           | ✓            | ✓            |              |             |             |              |              |              |             |             |              |              |              |             |             |             |              |              |              |             |             |              |              |              |   |      |          |          |        |        |  |  |  |  |  |  |  |
|              | 2               | Matte       | 10                |           |                   |               |                  |               |         |                 |                |             |             |              |              |              |             |             |              |              |              |             |             |              |              |              |             |             |             |              |              |              |             |             |              |              |              |   |      |          |          |        |        |  |  |  |  |  |  |  |
| Cast         | 2               | Matte       | 10                | Permanent | •                 | •             |                  |               |         |                 |                |             |             |              |              |              |             |             |              |              |              | ✓           | ✓           |              |              |              |             |             |             |              |              |              |             |             |              |              |              |   |      |          |          |        |        |  |  |  |  |  |  |  |
|              | 2               | Clear       | 8                 |           |                   |               |                  |               |         |                 |                |             |             |              |              |              |             |             |              |              |              |             |             |              |              |              |             |             |             |              |              |              |             |             |              |              |              |   |      |          |          |        |        |  |  |  |  |  |  |  |
| Cast         | 2               | 52% Light   | 7                 | Permanent |                   |               | •                | •             |         |                 |                |             |             |              |              |              |             |             |              |              |              |             |             |              |              |              |             |             | ✓           | ✓            | ✓            | ✓            |             |             |              |              |              |   |      |          |          | IJ3730 |        |  |  |  |  |  |  |  |
| Cast         | 2               | 63% Light   | 7                 | Permanent |                   |               | •                | •             |         |                 |                |             |             |              |              |              |             |             |              |              |              |             |             |              |              |              |             |             | ✓           | ✓            | ✓            | ✓            |             |             |              |              |              |   |      |          |          |        | IJ8150 |  |  |  |  |  |  |  |
| Cast         | 2               | Clear       | 7                 | Removable |                   |               |                  |               | •       |                 |                |             |             |              |              |              |             |             |              |              |              |             |             |              |              |              |             | ✓           | ✓           |              |              |              |             | ✓           | ✓            |              |              |   |      |          | IJ8624   |        |        |  |  |  |  |  |  |  |
| Cast         | 2               | Clear       | 7                 | Removable |                   |               |                  |               |         | •               |                |             |             |              |              |              |             |             |              |              |              |             |             |              |              |              |             | ✓           | ✓           |              |              |              |             | ✓           | ✓            |              |              |   |      |          |          |        |        |  |  |  |  |  |  |  |



Printable Vinyl / 3M



| Key Features |                 |             |                   | Application Areas |               |               | Available Sizes  |         |       |                |             |             |             |             |              |              |              |             |             |              | Item #       |              |              |             |             |             |              |              |              |              |             |             |              |              |              |              |   |   |       |        |        |
|--------------|-----------------|-------------|-------------------|-------------------|---------------|---------------|------------------|---------|-------|----------------|-------------|-------------|-------------|-------------|--------------|--------------|--------------|-------------|-------------|--------------|--------------|--------------|--------------|-------------|-------------|-------------|--------------|--------------|--------------|--------------|-------------|-------------|--------------|--------------|--------------|--------------|---|---|-------|--------|--------|
| Film Type    | Thickness (mil) | Face Finish | Durability (year) | Adhesive          | Vehicle Wraps | Outdoor Signs | POP / Trade Show | Windows | Walls | Floor Graphics | 27" x 10 yd | 27" x 25 yd | 27" x 50 yd | 30" x 50 yd | 30" x 100 yd | 30" x 150 yd | 30" x 200 yd | 48" x 10 yd | 48" x 50 yd | 48" x 100 yd | 48" x 150 yd | 48" x 200 yd | 48" x 250 yd | 54" x 10 yd | 54" x 25 yd | 54" x 50 yd | 54" x 100 yd | 54" x 150 yd | 54" x 200 yd | 54" x 250 yd | 60" x 10 yd | 60" x 50 yd | 60" x 100 yd | 60" x 150 yd | 60" x 200 yd | 60" x 250 yd |   |   |       |        |        |
| Calend.      | 4               | Matte       | 2                 | Removable         | ●             |               |                  | ●       |       |                |             |             |             |             | ✓            | ✓            | ✓            | ✓           | ✓           | ✓            | ✓            | ✓            | ✓            | ✓           | ✓           | ✓           | ✓            | ✓            | ✓            | ✓            | ✓           | ✓           | ✓            | ✓            | ✓            | ✓            | ✓ | ✓ | 3500C |        |        |
| Calend.      | 3               | Gloss       | 2                 | Removable         |               |               |                  |         | ●     |                |             |             |             | ✓           | ✓            | ✓            | ✓            |             |             |              |              |              |              |             |             |             |              |              |              |              |             |             |              |              |              |              |   |   |       | 40C    |        |
| Calend.      | 3               | Matte       | 2                 | Removable         |               |               |                  |         | ●     |                |             |             |             | ✓           | ✓            | ✓            | ✓            |             |             |              |              |              |              |             |             |             |              |              |              |              |             |             |              |              |              |              |   |   |       | IJ35   |        |
| Calend.      | 3               | Clear       | 2                 | Removable         |               |               |                  |         | ●     |                |             |             |             | ✓           | ✓            | ✓            | ✓            |             |             |              |              |              |              |             |             |             |              |              |              |              |             |             |              |              |              |              |   |   |       | IJ35C  |        |
| Calend.      | 3.2             | Gloss       | 5                 | Removable         | ●             | ●             |                  |         | ●     |                |             |             |             | ✓           | ✓            | ✓            | ✓            |             |             |              |              |              |              |             |             |             |              |              |              |              |             |             |              |              |              |              |   |   |       | IJ36   |        |
| Calend.      | 4               | Matte       | 2                 | Removable         | ●             | ●             | ●                | ●       | ●     |                |             |             |             |             |              |              |              | ✓           | ✓           | ✓            | ✓            |              |              |             |             |             |              |              |              |              |             |             |              |              |              |              |   |   |       | IJ3555 |        |
| Calend.      | 4               | Matte       | 2                 | Removable         | ●             | ●             | ●                | ●       | ●     |                |             |             |             |             |              |              |              | ✓           | ✓           | ✓            | ✓            |              |              |             |             |             |              |              |              |              |             |             |              |              |              |              |   |   |       | IJ46   |        |
| Calend.      | 4               | Matte       | 3                 | Removable         | ●             | ●             | ●                | ●       | ●     |                |             |             |             | ✓           | ✓            | ✓            | ✓            | ✓           | ✓           | ✓            |              |              |              |             |             |             |              |              |              |              |             |             |              |              |              |              |   |   |       |        | IJ160C |
| Calend.      | 3               | Gloss       | 6m                | Removable         |               |               |                  | ●       |       |                |             |             |             |             |              |              |              |             |             |              |              |              |              |             |             | ✓           |              |              |              |              |             |             |              |              |              |              |   |   |       | IJ61   |        |
| Calend.      | 3.2             | Matte       | 2                 | Removable         |               | ●             | ●                |         |       |                |             |             |             |             |              |              |              |             |             |              |              |              |              |             |             | ✓           | ✓            |              |              |              |             |             |              |              |              |              |   |   |       | IJ63   |        |
| Calend.      | 5.9             | Matte       | 1                 | Removable         |               |               |                  |         |       | ✓              | ✓           | ✓           |             |             |              |              |              |             |             |              |              |              |              |             | ✓           | ✓           | ✓            |              |              |              |             |             |              |              |              |              |   |   |       | IJ67   |        |

| Key Features    |                 |             |                   | Application Areas |               |               | Available Sizes |             |             |              |              |              |             |             |              |              |              |             |             |             | Item #       |              |              |   |  |  |  |  |  |  |  |  |  |  |  |  |  |  |  |  |         |         |        |
|-----------------|-----------------|-------------|-------------------|-------------------|---------------|---------------|-----------------|-------------|-------------|--------------|--------------|--------------|-------------|-------------|--------------|--------------|--------------|-------------|-------------|-------------|--------------|--------------|--------------|---|--|--|--|--|--|--|--|--|--|--|--|--|--|--|--|--|---------|---------|--------|
| Film Type       | Thickness (mil) | Face Finish | Durability (year) | Adhesive          | Vehicle Wraps | Outdoor Signs | Walls           | 24" x 10 yd | 24" x 50 yd | 24" x 100 yd | 24" x 150 yd | 24" x 200 yd | 36" x 10 yd | 36" x 50 yd | 36" x 100 yd | 36" x 150 yd | 36" x 200 yd | 48" x 10 yd | 48" x 25 yd | 48" x 50 yd | 48" x 100 yd | 48" x 150 yd | 48" x 200 yd |   |  |  |  |  |  |  |  |  |  |  |  |  |  |  |  |  |         |         |        |
| Retroreflective | 6               | Gloss       | 1.5               | Permanent         | ●             | ●             | ●               | ✓           | ✓           | ✓            | ✓            | ✓            |             |             |              |              |              |             |             |             |              |              |              |   |  |  |  |  |  |  |  |  |  |  |  |  |  |  |  |  |         | IJ5000  |        |
| Retroreflective | 7               | Gloss       | 7                 | Removable         | ●             |               |                 | ✓           | ✓           | ✓            | ✓            | ✓            |             |             |              |              |              |             |             |             |              |              |              |   |  |  |  |  |  |  |  |  |  |  |  |  |  |  |  |  |         |         | IJ5100 |
| Retroreflective | 7               | Gloss       | 7                 | Removable         | ●             |               |                 | ✓           | ✓           | ✓            | ✓            | ✓            |             |             |              |              |              |             | ✓           | ✓           | ✓            | ✓            | ✓            | ✓ |  |  |  |  |  |  |  |  |  |  |  |  |  |  |  |  |         | IJ5100R |        |
| Retroreflective | 7               | Gloss       | 9                 | Removable         | ●             |               |                 |             |             |              |              |              |             |             |              |              |              |             |             | ✓           | ✓            | ✓            | ✓            | ✓ |  |  |  |  |  |  |  |  |  |  |  |  |  |  |  |  | IJ680   |         |        |
| Retroreflective | 7               | Gloss       | 9                 | Removable         | ●             |               |                 |             |             |              |              |              | ✓           | ✓           | ✓            | ✓            | ✓            | ✓           | ✓           | ✓           | ✓            | ✓            | ✓            | ✓ |  |  |  |  |  |  |  |  |  |  |  |  |  |  |  |  | IJ680CR |         |        |

Printable Vinyl / Avery Dennison



Outdoor, Vehicle / Fleet & Transit Graphic Films



*Fleet branding, vehicle wraps, indoor and outdoor signage*

Supercast

**MPI 1105 Series**

**TIER 1**

Premium cast vinyl for superior conformability and maximum durability



High Performance Calendered

**MPI 2000 Series**

**TIER 2**

Premium calendered vinyl for slightly curved surfaces and moderate durability



Intermediate Calendered

**MPI 2900 Series**

**TIER 3**

Medium term durability films for flat applications



Promotional Calendered

**MPI 3300 Series**

**TIER 4**

Monomeric Vinyl for flat surface and short term durability



**Printable Vinyl / Avery Dennison**

| Key Features      |                 |             |                   |           | Application Areas |               |                  |               |         |       |                | Available Sizes |             |             |             |             |             |             |              |              |              | Item #       |              |              |   |               |
|-------------------|-----------------|-------------|-------------------|-----------|-------------------|---------------|------------------|---------------|---------|-------|----------------|-----------------|-------------|-------------|-------------|-------------|-------------|-------------|--------------|--------------|--------------|--------------|--------------|--------------|---|---------------|
| Film Type         | Thickness (mil) | Face Finish | Durability (year) | Adhesive  | Vehicle Wraps     | Outdoor Signs | POP / Trade Show | Backlit Signs | Windows | Walls | Floor Graphics | 54" x 25 yd     | 60" x 25 yd | 15" x 50 yd | 30" x 50 yd | 48" x 50 yd | 54" x 50 yd | 60" x 50 yd | 48" x 100 yd | 54" x 100 yd | 60" x 100 yd | 48" x 250 yd | 54" x 250 yd | 60" x 250 yd |   |               |
| Supercast         | 2.1             | Gloss       | 9                 | Permanent |                   | ●             | ●                | ●             | ●       |       | ●              |                 |             |             |             | ✓           |             | ✓           | ✓            |              | ✓            |              |              |              |   | MPI1060       |
| Supercast         | 2               | Gloss       | 7                 | Removable | ●                 | ●             | ●                |               |         | ●     |                |                 |             |             |             | ✓           | ✓           | ✓           |              |              |              |              |              |              |   | MPI1105SC     |
| Supercast         | 2               | Gloss       | 7                 | Removable | ●                 | ●             | ●                |               |         | ●     |                |                 |             |             |             | ✓           | ✓           | ✓           | ✓            | ✓            | ✓            | ✓            | ✓            | ✓            | ✓ | MPI1105SCEZ   |
| Supercast         | 2               | Gloss       | 7                 | Removable | ●                 | ●             | ●                |               |         | ●     |                | ✓               |             |             |             | ✓           | ✓           | ✓           |              | ✓            | ✓            |              | ✓            | ✓            |   | MPI1105SCEZRS |
| Supercast         | 2               | Gloss       | 2                 | Removable |                   | ●             | ●                |               |         | ●     |                |                 |             |             |             | ✓           | ✓           |             |              |              |              |              |              |              |   | MPI1405       |
| Supercast         | 2               | Gloss       | 7                 | Permanent | ●                 |               |                  |               |         |       |                |                 |             |             |             | ✓           | ✓           |             |              |              |              |              |              |              |   | MPI1106HTEZ   |
| H.P. Calendered   | 3.4             | Matte       | 6                 | Permanent |                   |               |                  | ●             |         |       | ✓              |                 |             |             |             | ✓           | ✓           |             |              |              |              |              |              |              |   | MPI2050       |
| H.P. Calendered   | 4               | Luster      | 4                 | Removable |                   |               |                  |               | ●       |       |                |                 |             |             |             | ✓           |             |             |              |              |              |              |              |              |   | MPI2077       |
| H.P. Calendered   | 3.1             | Gloss       | 6                 | Removable | ●                 | ●             | ●                |               | ●       |       |                |                 |             |             |             | ✓           | ✓           |             |              | ✓            |              |              |              |              |   | MPI2105       |
| H.P. Calendered   | 7               | Matte       | 6                 | Permanent | ●                 | ●             | ●                |               | ●       |       |                |                 |             | ✓           | ✓           | ✓           | ✓           | ✓           | ✓            | ✓            | ✓            |              |              |              |   | MPI2120       |
| H.P. Calendered   | 3.4             | Matte       | 1                 | Removable | ●                 | ●             | ●                |               | ●       | ●     | ●              |                 |             |             |             | ✓           |             |             | ✓            |              |              |              |              |              |   | MPI2121       |
| H.P. Calendered   | 3.4             | Matte       | 6                 | Permanent | ●                 |               |                  |               |         |       |                |                 |             |             |             | ✓           | ✓           |             |              |              |              |              |              |              |   | MPI2126       |
| H.P. Calendered   | 6               | Matte       | 4                 | Permanent |                   |               | ●                |               |         | ●     | ✓              |                 |             |             |             | ✓           | ✓           |             |              |              |              |              |              |              |   | MPI2610       |
| H.P. Calendered   | 6               | Matte       | 4                 | Removable |                   |               | ●                |               |         | ●     | ✓              |                 |             |             |             | ✓           |             |             |              | ✓            |              |              |              |              |   | MPI2611       |
| H.P. Calendered   | 6               | Textured    | 2                 | Permanent | ●                 | ●             |                  |               |         | ●     | ●              | ✓               | ✓           |             |             |             |             |             |              |              |              |              |              |              |   | MPI2630       |
| H.P. Calendered   | 6               | Textured    | 2                 | Permanent | ●                 | ●             |                  |               |         | ●     | ●              | ✓               | ✓           |             |             |             |             |             |              |              |              |              |              |              |   | MPI2630C      |
| H.P. Calendered   | 6               | Textured    | 2                 | Permanent | ●                 | ●             |                  |               |         | ●     | ●              | ✓               | ✓           |             |             |             |             |             |              |              |              |              |              |              |   | MPI2630CS     |
| H.P. Calendered   | 6               | Textured    | 2                 | Permanent | ●                 | ●             |                  |               |         | ●     | ●              | ✓               | ✓           |             |             |             |             |             |              |              |              |              |              |              |   | MPI2630S      |
| H.P. Calendered   | 6               | Textured    | 2                 | Removable |                   |               | ●                |               |         | ●     | ✓              | ✓               |             |             |             |             |             |             |              |              |              |              |              |              |   | MPI2631       |
| H.P. Calendered   | 6               | Textured    | 2                 | Removable |                   |               | ●                |               |         | ●     | ✓              | ✓               |             |             |             |             |             |             |              |              |              |              |              |              |   | MPI2631C      |
| H.P. Calendered   | 6               | Textured    | 2                 | Removable |                   |               | ●                |               |         | ●     | ✓              | ✓               |             |             |             |             |             |             |              |              |              |              |              |              |   | MPI2631S      |
| Inter. Calendered | 3               | Gloss       | 4                 | Permanent |                   | ●             | ●                |               | ●       |       |                |                 |             |             |             |             | ✓           |             |              |              |              |              |              |              |   | MPI2900       |
| Inter. Calendered | 3               | Gloss       | 4                 | Permanent |                   | ●             | ●                |               | ●       |       |                |                 |             |             |             |             | ✓           |             |              |              |              |              |              |              |   | MPI2902       |
| Inter. Calendered | 3               | Gloss       | 4                 | Permanent |                   | ●             | ●                |               | ●       |       |                |                 |             | ✓           | ✓           | ✓           | ✓           |             |              | ✓            |              |              |              |              |   | MPI2903       |
| Inter. Calendered | 7               | Matte       | 3                 | Removable | ●                 |               |                  |               | ●       |       | ✓              |                 |             |             |             |             |             |             |              |              |              |              |              |              |   | MPI2528       |
| Inter. Calendered | 7               | Textured    | 4                 | Removable |                   |               |                  |               |         | ●     | ✓              |                 |             |             |             |             |             |             |              |              |              |              |              |              |   | MPI2728       |
| Inter. Calendered | 3.4             | Matte       | 5                 | Permanent |                   | ●             | ●                |               | ●       |       |                |                 |             |             |             |             | ✓           |             |              |              |              |              |              |              |   | MPI2920       |
| Inter. Calendered | 3               | Gloss       | 4                 | Permanent |                   | ●             | ●                |               |         | ●     |                |                 |             |             |             |             | ✓           |             |              |              |              |              |              |              |   | MPI2903EZ     |
| Inter. Calendered | 3.4             | Matte       | 4                 | Removable | ●                 | ●             | ●                |               | ●       | ●     | ●              |                 |             |             |             | ✓           | ✓           |             |              | ✓            | ✓            |              |              |              |   | MPI2921       |
| Inter. Calendered | 3.4             | Matte       | 4                 | Removable | ●                 | ●             | ●                |               |         | ●     | ●              |                 |             |             | ✓           |             | ✓           |             |              |              |              |              |              |              |   | MPI2922       |
| Inter. Calendered | 3.4             | Matte       | 5                 | Permanent |                   | ●             | ●                |               |         | ●     |                |                 |             | ✓           | ✓           | ✓           | ✓           |             |              | ✓            |              |              |              |              |   | MPI2923       |
| Inter. Calendered | 3.4             | Matte       | 5                 | Permanent | ●                 | ●             | ●                |               |         |       |                |                 |             |             |             | ✓           |             |             |              |              |              |              |              |              |   | MPI2923EZ     |
| Promo Calendered  | 3               | Gloss       | 4                 | Permanent |                   | ●             | ●                |               |         | ●     | ●              |                 |             |             |             |             | ✓           |             |              |              |              |              |              |              |   | MPI3300       |
| Promo Calendered  | 3               | Gloss       | 4                 | Removable |                   | ●             | ●                |               | ●       |       |                |                 |             | ✓           |             | ✓           | ✓           |             |              |              | ✓            |              |              |              |   | MPI3302       |
| Promo Calendered  | 3               | Gloss       | 4                 | Permanent |                   | ●             | ●                |               |         | ●     | ●              |                 |             |             | ✓           |             | ✓           | ✓           |              | ✓            | ✓            |              |              |              |   | MPI3303       |
| Promo Calendered  | 3.4             | Matte       | 4                 | Permanent |                   | ●             | ●                |               |         | ●     | ●              |                 |             |             | ✓           |             |             |             |              |              |              |              |              |              |   | MPI3320       |
| Promo Calendered  | 3.4             | Matte       | 4                 | Removable |                   | ●             | ●                |               |         | ●     | ●              |                 |             |             | ✓           |             | ✓           | ✓           |              | ✓            | ✓            |              |              |              |   | MPI3322       |
| Promo Calendered  | 3               | Matte       | 4                 | Permanent |                   | ●             | ●                |               |         | ●     | ●              |                 |             |             | ✓           |             | ✓           | ✓           |              | ✓            | ✓            |              |              |              |   | MPI3323       |
| Promo Calendered  | 2.6             | Gloss       | 1                 | Removable |                   | ●             | ●                |               |         | ●     |                |                 |             |             | ✓           |             | ✓           | ✓           |              | ✓            | ✓            |              |              |              |   | MPI3901       |



Printable Vinyl / General Formulations



Outdoor, Vehicle /  
Fleet & Transit  
Graphic Films



Businesses of all sizes enjoy the vibrant color pop and high quality output across a wide range of applications including fleet branding and signage to amplify their brand messaging.

- Vibrant printed wrapping graphics and colors
- Ease of installation and removal
- Vehicle Wraps
- Outdoor Signs
- POP / Trade Shows
- Windows
- Walls
- Floors





**Printable Vinyl / General Formulations**

| Key Features |                 |              |                   | Application Areas |               |               |                  |         | Available Sizes |                |             |             |             |             |             |             |             |             | Item #      |             |             |   |             |
|--------------|-----------------|--------------|-------------------|-------------------|---------------|---------------|------------------|---------|-----------------|----------------|-------------|-------------|-------------|-------------|-------------|-------------|-------------|-------------|-------------|-------------|-------------|---|-------------|
| Film Type    | Thickness (mil) | Face Finish  | Durability (year) | Adhesive          | Vehicle Wraps | Outdoor Signs | POP / Trade Show | Windows | Walls           | Floor Graphics | 24" x 25 yd | 30" x 25 yd | 54" x 25 yd | 60" x 25 yd | 30" x 30 yd | 54" x 30 yd | 60" x 30 yd | 24" x 50 yd | 30" x 50 yd | 54" x 50 yd | 60" x 50 yd |   |             |
| Calendered   | 3.4             | Matte        | 5                 | Permanent         |               | ●             | ●                |         |                 |                |             |             |             |             |             |             |             |             |             | ✓           | ✓           | ✓ | GF201       |
| Calendered   | 3.4             | Matte        | 5                 | Permanent         |               | ●             | ●                | ●       |                 |                |             |             |             |             |             |             |             |             |             |             | ✓           | ✓ | GF201HTAP   |
| Calendered   | 3.4             | Matte        | 5                 | Permanent         |               | ●             | ●                | ●       |                 |                |             |             |             |             |             |             |             |             |             |             | ✓           | ✓ | GF201HTAPAE |
| Calendered   | 3.4             | Matte        | 5                 | Permanent         |               | ●             | ●                |         |                 |                |             |             |             |             |             |             |             |             |             | ✓           | ✓           | ✓ | GF201-OAP   |
| Calendered   | 3.4             | Matte        | 5                 | Permanent         |               | ●             | ●                |         |                 |                |             |             |             |             |             |             |             |             |             |             | ✓           | ✓ | GF201-OAPAE |
| Calendered   | 3.4             | Matte        | 5                 | Removable         |               | ●             | ●                | ●       |                 |                |             |             |             |             |             |             |             |             |             | ✓           | ✓           | ✓ | GF202       |
| Calendered   | 3               | Gloss        | 5                 | Permanent         |               | ●             | ●                |         |                 |                |             |             |             |             |             |             |             |             |             | ✓           | ✓           | ✓ | GF203       |
| Calendered   | 3               | Gloss        | 5                 | Permanent         |               | ●             | ●                |         |                 |                |             |             |             |             |             |             |             |             |             | ✓           | ✓           | ✓ | GF203-OAP   |
| Calendered   | 3               | Gloss        | 5                 | Permanent         |               | ●             | ●                |         |                 |                |             |             |             |             |             |             |             |             |             |             | ✓           | ✓ | GF203-OAPAE |
| Calendered   | 3               | Gloss        | 5                 | Removable         |               | ●             | ●                | ●       |                 |                |             |             |             |             |             |             |             |             |             | ✓           | ✓           | ✓ | GF204       |
| Calendered   | 3               | Clear Gloss  | 3                 | Permanent         |               | ●             | ●                |         |                 |                |             |             |             |             |             |             |             |             |             | ✓           | ✓           | ✓ | GF205       |
| Calendered   | 3               | Clear Gloss  | 3                 | Removable         |               | ●             | ●                | ●       |                 |                |             |             |             |             |             |             |             |             |             | ✓           | ✓           | ✓ | GF206       |
| Calendered   | 3.5             | Matte        | 5                 | Removable         | ●             | ●             | ●                | ●       | ●               |                |             |             |             |             |             | ✓           | ✓           |             |             |             |             |   | GF209       |
| Calendered   | 3.4             | Matte        | 5                 | Removable         |               | ●             | ●                |         |                 | ●              |             |             |             |             |             |             |             |             |             |             | ✓           | ✓ | GF210       |
| Calendered   | 3.7             | Clear Matte  | 6m                | Removable         |               | ●             | ●                |         |                 | ●              |             |             |             |             |             |             |             |             |             |             | ✓           | ✓ | GF212       |
| Calendered   | 3.7             | Clear Matte  | 1                 | Permanent         |               | ●             | ●                |         |                 | ●              |             |             |             |             |             |             |             |             |             |             | ✓           | ✓ | GF213       |
| Calendered   | 3.2             | Matte        | 3                 | Permanent         |               | ●             | ●                |         |                 |                |             |             |             |             |             |             |             |             |             | ✓           | ✓           | ✓ | GF214       |
| Calendered   | 3.2             | Gloss        | 3                 | Permanent         |               | ●             | ●                |         |                 |                |             |             |             |             |             |             |             |             |             | ✓           | ✓           | ✓ | GF216       |
| Monomeric    | 8               | Gloss        | 3                 | Removable         |               | ●             | ●                |         | ●               |                |             |             |             |             |             | ✓           | ✓           |             |             |             |             |   | GF218       |
| Calendered   | 6               | Gloss        | 3                 | Permanent         |               | ●             | ●                |         |                 |                |             |             |             |             | ✓           | ✓           | ✓           |             |             |             |             |   | GF220       |
| Calendered   | 6               | Gloss        | 3                 | Removable         |               | ●             | ●                |         | ●               |                |             |             |             |             | ✓           | ✓           | ✓           |             |             |             |             |   | GF221       |
| Calendered   | 6               | Matte        | 3                 | Permanent         |               | ●             | ●                |         |                 |                |             |             |             |             | ✓           | ✓           | ✓           |             |             |             |             |   | GF222       |
| Calendered   | 6               | Matte        | 3                 | Removable         |               | ●             | ●                |         | ●               |                |             |             |             |             | ✓           | ✓           | ✓           |             |             |             |             |   | GF223       |
| Calendered   | 3.2             | Translucent  | 5                 | Permanent         |               | ●             | ●                | ●       | ●               |                |             |             |             |             |             |             |             |             |             | ✓           | ✓           | ✓ | GF224       |
| Calendered   | 6               | Matte        | 5                 | Removable         |               |               |                  |         |                 | ●              |             |             |             |             |             | ✓           | ✓           |             |             |             |             |   | GF226       |
| Calendered   | 3               | Translucent  | 3                 | Removable         | ●             | ●             | ●                |         | ●               |                |             |             |             |             |             |             |             |             |             |             | ✓           | ✓ | GF228       |
| Calendered   | 6               | Matte        | 3                 | Removable         |               |               |                  |         |                 | ●              |             |             |             |             |             | ✓           | ✓           |             |             |             |             |   | GF229       |
| Calendered   | 2.4             | Gloss        | 7                 | Repositionable    | ●             |               |                  |         |                 |                |             |             |             |             |             | ✓           | ✓           |             |             |             |             |   | GF230       |
| Calendered   | 4               | Gloss        | 5                 | Permanent         | ●             | ●             |                  |         |                 |                |             | ✓           |             |             |             |             |             |             | ✓           |             | ✓           | ✓ | GF235       |
| Calendered   | 2.4             | Gloss        | 7                 | Repositionable    | ●             | ●             | ●                |         |                 |                |             |             |             |             |             |             |             |             |             |             | ✓           | ✓ | GF246       |
| Calendered   | 2.4             | Clear Gloss  | 7                 | Permanent         | ●             | ●             | ●                | ●       |                 |                |             |             |             |             |             |             |             |             |             |             | ✓           | ✓ | GF247       |
| Calendered   | 3.5             | Matte        | 5                 | Permanent         |               | ●             | ●                |         |                 | ●              |             |             |             |             |             |             |             |             |             | ✓           | ✓           | ✓ | GF275       |
| Calendered   | 3.5             | Matte        | 5                 | Removable         |               | ●             | ●                |         |                 | ●              |             |             |             |             |             |             |             |             |             |             | ✓           | ✓ | GF285       |
| Calendered   | 3               | Clear Matte  | 5                 | Removable         |               | ●             | ●                |         |                 | ●              |             | ✓           | ✓           |             |             |             |             |             |             |             | ✓           | ✓ | GF287       |
| Chalkboard   | 5               | Black Matte  | 3                 | Removable         |               | ●             | ●                |         | ●               | ●              |             | ✓           | ✓           |             |             |             |             |             | ✓           |             | ✓           |   | GF290       |
| Calendered   | 5.6             | Black Carbon | 5                 | Repositionable    | ●             | ●             | ●                |         | ●               | ●              |             |             |             |             | ✓           |             |             |             |             | ✓           |             |   | GF780       |
| Polymeric    | 5               | Clear        | 7                 | Clear             |               |               |                  |         | ●               |                |             | ✓           |             |             |             |             |             |             |             |             |             |   | GF790AE     |



Printable Vinyl / KONG



Outdoor, Vehicle / Fleet & Transit and Floor Graphic Films

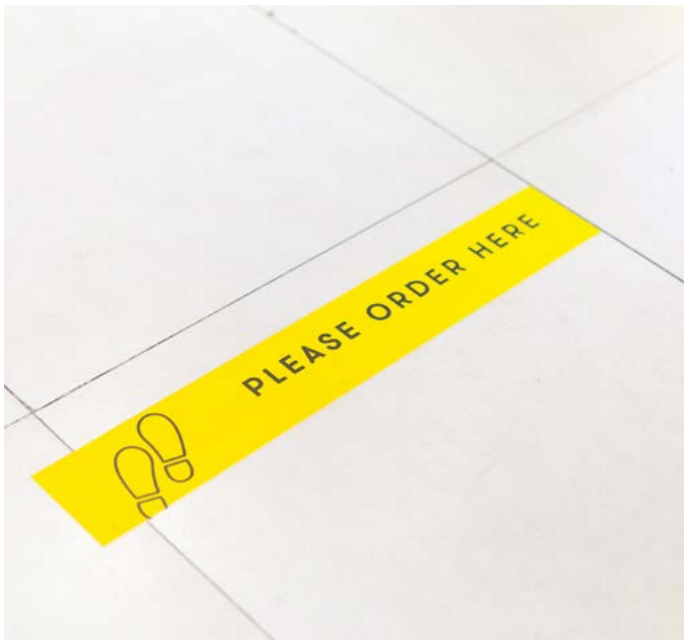

Floor Vinyl

| Key Features   |                 |             |                   | Application Areas |               |                  | Available Sizes |           |           |           |           |           |            |            | Item #     |            |            |                     |
|----------------|-----------------|-------------|-------------------|-------------------|---------------|------------------|-----------------|-----------|-----------|-----------|-----------|-----------|------------|------------|------------|------------|------------|---------------------|
| Film Type      | Thickness (mil) | Face Finish | Durability (year) | Adhesive          | Outdoor Signs | POP / Trade Show | Floor Graphics  | 24" x 10' | 27" x 10' | 48" x 33' | 54" x 33' | 48" x 82' | 48" x 100' | 54" x 100' | 38" x 150' | 52" x 150' | 54" x 150' |                     |
| Poly-Cotton    | 5               | Gloss       | 1                 | Removable         | ●             | ●                | ●               |           |           |           |           |           |            |            | ✓          |            | ✓          | 5300 Asphalt Art    |
| Textured Vinyl | 5               | Matte       | 3m                | Removable         | ●             | ●                | ●               |           | ✓         |           | ✓         |           |            | ✓          |            |            |            | 5307 Catwalk        |
| Textured Vinyl | 20              | Clear       | 3m                | Removable         | ●             | ●                | ●               |           | ✓         |           | ✓         |           |            | ✓          |            |            |            | 5315 Clearwalk      |
| Textured Vinyl | 20              | Matte       | 1w                | Removable         | ●             | ●                | ●               |           | ✓         |           | ✓         |           |            | ✓          |            |            |            | 5320 Sportwalk      |
| Textured Vinyl | 8               | Matte       | 1w                | Repositionable    | ●             | ●                | ●               | ✓         |           | ✓         |           | ✓         | ✓          |            |            |            |            | 5325 Textwalk       |
| Vinyl          | 8               | Matte       | 3m                | Removable         | ●             | ●                | ●               |           |           |           |           |           |            |            | ✓          |            | ✓          | 5410 One Step Floor |



Printable Vinyl / KONG



| Key Features |                 |             |                   |                | Application Areas |                  |       | Available Sizes |            |            |            |            |            |            |            | Item #     |               |
|--------------|-----------------|-------------|-------------------|----------------|-------------------|------------------|-------|-----------------|------------|------------|------------|------------|------------|------------|------------|------------|---------------|
| Film Type    | Thickness (mil) | Face Finish | Durability (year) | Adhesive       | Outdoor Signs     | POP / Trade Show | Walls | 42" x 100'      | 50" x 100' | 54" x 100' | 60" x 100' | 30" x 150' | 38" x 150' | 54" x 150' | 60" x 150' | 62" x 150' |               |
| Calendered   | 8               | Translucent | 6m                | Removable      | ●                 | ●                | ●     | ✓               | ✓          | ✓          | ✓          |            |            |            |            |            | 5089 PhotoTex |
| Premium      | 3               | Gloss       | 6m                | Permanent      | ●                 | ●                | ●     |                 |            |            |            | ✓          |            | ✓          | ✓          |            | 5099          |
| Premium      | 3               | Clear       | 3                 | Removable      | ●                 | ●                | ●     |                 |            |            |            |            | ✓          | ✓          | ✓          |            | 5108          |
| Premium      | 3               | Gloss       | 5                 | Permanent      | ●                 | ●                | ●     |                 |            |            |            | ✓          | ✓          | ✓          |            | ✓          | 5118          |
| Calendered   | 3               | Gloss       | 6m                | Removable      | ●                 | ●                | ●     |                 |            |            |            | ✓          |            | ✓          |            | ✓          | 5128          |
| Calendered   | 3.2             | Gloss       | 3                 | Permanent      | ●                 | ●                | ●     |                 |            |            |            |            | ✓          | ✓          | ✓          |            | 5145          |
| Premium      | 3               | Matte       | 5                 | Permanent      | ●                 | ●                | ●     |                 |            |            |            | ✓          | ✓          | ✓          |            | ✓          | 5158          |
| Calendered   | 3               | Matte       | 1                 | Removable      | ●                 | ●                | ●     |                 |            |            |            | ✓          | ✓          | ✓          |            | ✓          | 5167          |
| Calendered   | 6               | Matte       | 6                 | Permanent      | ●                 | ●                | ●     |                 |            | ✓          |            |            |            |            |            |            | 5195          |
| Calendered   | 6               | Gloss       | 5                 | Removable      | ●                 | ●                | ●     |                 |            | ✓          |            |            |            |            |            |            | 5199          |
| Calendered   | 3.2             | Matte       | 5                 | Permanent      | ●                 | ●                | ●     |                 |            |            |            | ✓          |            | ✓          |            |            | 5174          |
| Calendered   | 5               | Matte       | 4                 | Repositionable |                   |                  | ●     |                 |            |            |            |            |            | ✓          |            |            | 5230 WallFrog |
| Calendered   | 5               | Clear       | 2                 | Repositionable | ●                 | ●                | ●     |                 |            |            |            |            |            | ✓          |            |            | 5234          |
| Calendered   | 5               | Gloss       | 4                 | Removable      | ●                 | ●                | ●     |                 |            |            |            |            |            | ✓          |            |            | 5238          |
| Calendered   | 3.2             | Matte       | 3                 | Permanent      | ●                 | ●                | ●     |                 |            |            |            |            | ✓          | ✓          | ✓          |            | 5254          |
| Calendered   | 3.2             | Translucent | 3                 | Permanent      |                   | ●                |       |                 |            |            |            |            | ✓          | ✓          | ✓          |            | 5260          |
| Calendered   | 4               | Gloss       | 3                 | Permanent      | ●                 | ●                |       |                 |            |            |            |            | ✓          | ✓          | ✓          |            | 5270          |
| Calendered   | 4               | Matte       | 3                 | Permanent      | ●                 |                  |       |                 |            |            |            |            |            | ✓          |            |            | 5275          |



Overlaminates Films / Avery Dennison



Pressure-Sensitive Overlaminates



| Key Features |                 |                      |                   | Application Areas |               |                  |               |         |       |                | Available Sizes |             |             |             |             |             |             | Item #       |              |          |
|--------------|-----------------|----------------------|-------------------|-------------------|---------------|------------------|---------------|---------|-------|----------------|-----------------|-------------|-------------|-------------|-------------|-------------|-------------|--------------|--------------|----------|
| Film Type    | Thickness (mil) | Clear Finish         | Durability (year) | Vehicle Wraps     | Outdoor Signs | POP / Trade Show | Backlit Signs | Windows | Walls | Floor Graphics | 54" x 5 yd      | 54" x 25 yd | 30" x 50 yd | 38" x 50 yd | 48" x 50 yd | 54" x 50 yd | 60" x 50 yd | 48" x 100 yd | 54" x 100 yd |          |
| Cast         | 2.1             | High Gloss           | 5                 | ●                 | ●             | ●                | ●             | ●       | ●     | ●              | ✓               | ✓           | ✓           |             | ✓           | ✓           | ✓           | ✓            | ✓            | DOL1060Z |
| Cast         | 2.1             | Matte                | 4                 | ●                 | ●             | ●                | ●             | ●       | ●     | ●              | ✓               | ✓           | ✓           |             | ✓           | ✓           |             |              | ✓            | DOL1080Z |
| Cast         | 1.3             | Optically High Gloss | 4                 | ●                 | ●             | ●                | ●             | ●       | ●     | ●              | ✓               | ✓           | ✓           |             | ✓           | ✓           | ✓           |              |              | DOL1360Z |
| Cast         | 1.3             | Luster               | 4                 | ●                 | ●             | ●                | ●             | ●       | ●     | ●              | ✓               | ✓           |             |             | ✓           | ✓           | ✓           |              |              | DOL1370Z |
| Cast         | 1.3             | Matte                | 4                 | ●                 | ●             | ●                | ●             | ●       | ●     | ●              | ✓               | ✓           |             |             | ✓           | ✓           | ✓           |              |              | DOL1380Z |
| Cast         | 1.3             | High Gloss           | 4                 | ●                 | ●             | ●                | ●             | ●       | ●     | ●              | ✓               | ✓           |             |             | ✓           | ✓           | ✓           |              |              | DOL1460Z |
| Calendered   | 3.1             | Gloss                | 3                 | ●                 | ●             | ●                | ●             | ●       | ●     | ●              |                 | ✓           | ✓           | ✓           | ✓           | ✓           | ✓           |              |              | DOL2060  |
| Calendered   | 3.1             | Luster               | 3                 | ●                 | ●             | ●                | ●             | ●       | ●     | ●              |                 | ✓           | ✓           |             | ✓           | ✓           | ✓           |              |              | DOL2070  |
| Calendered   | 3.1             | Matte                | 3                 | ●                 | ●             | ●                | ●             | ●       | ●     | ●              |                 |             | ✓           |             | ✓           | ✓           | ✓           |              |              | DOL2080  |
| Calendered   | 3.2             | Gloss                | 2                 |                   | ●             | ●                | ●             | ●       | ●     | ●              |                 |             | ✓           |             | ✓           | ✓           | ✓           |              |              | DOL3060  |
| Calendered   | 3.2             | Luster               | 2                 |                   | ●             | ●                | ●             | ●       | ●     | ●              |                 |             | ✓           |             | ✓           | ✓           | ✓           |              |              | DOL3070  |
| Calendered   | 3.2             | Matte                | 2                 |                   | ●             | ●                | ●             | ●       | ●     | ●              |                 |             | ✓           |             | ✓           | ✓           | ✓           |              |              | DOL3080  |
| Cast         | 3               | Sparkle High Gloss   | 2                 | ●                 | ●             | ●                |               | ●       | ●     |                |                 |             |             |             | ✓           | ✓           | ✓           |              |              | DOL6040  |
| Calendered   | 3.2             | Gloss                | 2                 |                   | ●             | ●                | ●             | ●       | ●     |                | ✓               |             |             |             | ✓           | ✓           | ✓           |              |              | DOL6060  |
| Polyurethane | 3               | High Gloss           | 2                 | ●                 | ●             | ●                | ●             | ●       | ●     |                |                 |             |             |             | ✓           | ✓           |             |              |              | DOL6460  |



Overlamine Films / General Formulations



Pressure-Sensitive Overlaminates

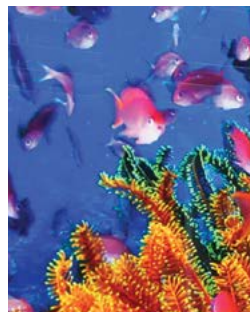
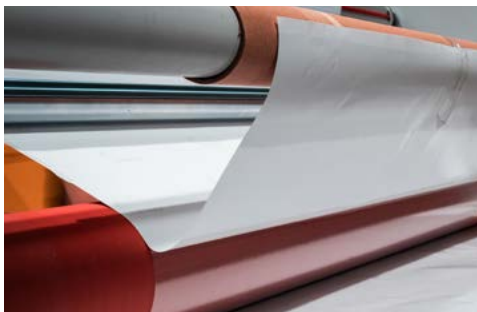

| Key Features  |                 |              |                   | Application Areas |               |                  |               |         |       | Available Sizes |             |             |             |             |             |             |             | Item #      |             |             |             |   |       |
|---------------|-----------------|--------------|-------------------|-------------------|---------------|------------------|---------------|---------|-------|-----------------|-------------|-------------|-------------|-------------|-------------|-------------|-------------|-------------|-------------|-------------|-------------|---|-------|
| Film Type     | Thickness (mil) | Clear Finish | Durability (year) | Vehicle Wraps     | Outdoor Signs | POP / Trade Show | Backlit Signs | Windows | Walls | Floor Graphics  | 24" x 25 yd | 30" x 25 yd | 30" x 50 yd | 31" x 50 yd | 38" x 50 yd | 51" x 50 yd | 54" x 25 yd | 54" x 50 yd | 60" x 25 yd | 60" x 50 yd | 61" x 50 yd |   |       |
| Calendered    | 3               | Gloss        | 1                 |                   | ●             | ●                | ●             |         | ●     |                 |             |             |             |             | ✓           | ✓           |             |             |             |             |             | ✓ | GF100 |
| Calendered    | 3               | Luster       | 1                 |                   | ●             | ●                | ●             |         | ●     |                 |             |             |             | ✓           | ✓           | ✓           |             |             |             |             |             | ✓ | GF101 |
| Calendered    | 3               | Matte        | 1                 |                   | ●             | ●                | ●             |         | ●     |                 |             |             |             | ✓           | ✓           | ✓           |             |             |             |             |             | ✓ | GF102 |
| Polycarbonate | 5               | Matte        | 1                 |                   | ●             | ●                | ●             |         | ●     |                 |             |             |             |             | ✓           | ✓           |             |             |             |             |             |   | GF103 |
| Polyester     | 2               | Gloss        | 2                 |                   | ●             | ●                |               |         |       |                 |             |             |             | ✓           | ✓           | ✓           |             |             |             |             |             | ✓ | GF105 |
| Tedlar PVF    | 1               | Gloss        | 2                 | ●                 | ●             | ●                |               | ●       | ●     |                 |             |             |             |             |             |             |             |             |             |             |             | ✓ | GF108 |
| Polymeric     | 5               | Matte        | 1                 |                   |               | ●                |               |         |       | ●               |             |             |             |             | ✓           | ✓           |             |             |             |             |             |   | GF109 |
| Polypropylene | 2               | Gloss        | 5                 |                   |               | ●                |               | ●       | ●     |                 |             |             |             |             | ✓           |             |             |             |             |             |             |   | GF110 |
| Polypropylene | 2               | Gloss        | 6m                |                   |               | ●                |               | ●       | ●     |                 |             |             |             |             | ✓           | ✓           |             |             |             |             |             |   | GF111 |
| Polypropylene | 6               | Gloss        | 1                 |                   |               | ●                |               |         |       | ●               |             |             |             |             |             |             |             |             |             |             |             |   | GF211 |
| Monomeric     | 3               | Gloss        | 6m                |                   |               | ●                |               |         |       | ●               |             |             |             |             |             |             |             |             |             |             |             |   | GF217 |
| Monomeric     | 12              | Gloss        | 5                 |                   | ●             |                  |               |         |       |                 | ✓           | ✓           |             |             |             |             |             |             |             |             |             |   | GF231 |
| Monomeric     | 12              | Gloss        | 5                 |                   | ●             |                  |               |         |       |                 | ✓           | ✓           |             |             |             |             |             |             |             |             |             |   | GF238 |
| Polymeric     | 2.4             | Gloss        | 7                 | ●                 |               |                  |               |         |       |                 |             |             |             |             |             |             |             |             |             |             |             |   | GF240 |
| Cast          | 2               | Gloss        | 5                 | ●                 |               |                  | ●             | ●       |       |                 |             |             |             |             |             |             |             |             |             |             |             |   | GF242 |
| Cast          | 3               | Gloss        | 4                 |                   | ●             | ●                | ●             |         |       |                 |             |             |             | ✓           | ✓           |             |             |             |             |             |             |   | GF400 |
| Calendered    | 3               | Luster       | 1                 |                   | ●             | ●                | ●             |         |       |                 |             |             |             | ✓           | ✓           |             |             |             |             |             |             |   | GF401 |
| Calendered    | 3               | Matte        | 1                 |                   | ●             | ●                | ●             |         |       |                 |             |             |             | ✓           | ✓           |             |             |             |             |             |             |   | GF402 |



Overlaminates Films / KONG



Pressure-Sensitive  
Overlaminates



| Key Features |                 | Application Areas |                  |               |         |       | Available Sizes |            |            |            |            |            |            |            |            |            |            | Item #     |            |      |
|--------------|-----------------|-------------------|------------------|---------------|---------|-------|-----------------|------------|------------|------------|------------|------------|------------|------------|------------|------------|------------|------------|------------|------|
| Finish       | Thickness (mil) | Outdoor Signs     | POP / Trade Show | Backlit Signs | Windows | Walls | 25" x 250'      | 38" x 250' | 43" x 250' | 51" x 250' | 55" x 250' | 62" x 250' | 25" x 500' | 38" x 500' | 43" x 500' | 51" x 500' | 55" x 500' | 61" x 500' | 62" x 500' |      |
| Gloss        | 3               | ●                 | ●                | ●             | ●       | ●     |                 |            |            |            |            |            | ✓          | ✓          | ✓          | ✓          | ✓          | ✓          |            | 3602 |
| Gloss        | 5               | ●                 | ●                | ●             | ●       | ●     |                 |            |            |            |            |            | ✓          | ✓          | ✓          | ✓          | ✓          |            | ✓          | 3620 |
| Satin        | 3               | ●                 | ●                | ●             | ●       | ●     |                 |            |            |            |            |            | ✓          | ✓          | ✓          | ✓          | ✓          | ✓          |            | 3660 |
| Satin        | 5               | ●                 | ●                | ●             | ●       | ●     | ✓               | ✓          | ✓          | ✓          | ✓          |            |            |            |            |            |            |            |            | 3691 |
| Matte        | 3               | ●                 | ●                | ●             | ●       | ●     |                 | ✓          |            | ✓          |            |            |            |            |            |            |            |            |            | 3670 |
| Textured     | 5               | ●                 | ●                | ●             | ●       | ●     |                 |            |            |            |            |            |            | ✓          |            | ✓          |            |            |            | 3685 |
| Low Luster   | 5               | ●                 | ●                | ●             | ●       | ●     |                 | ✓          | ✓          | ✓          |            |            |            |            |            |            |            |            |            | 3680 |



## BANNER ROLLS

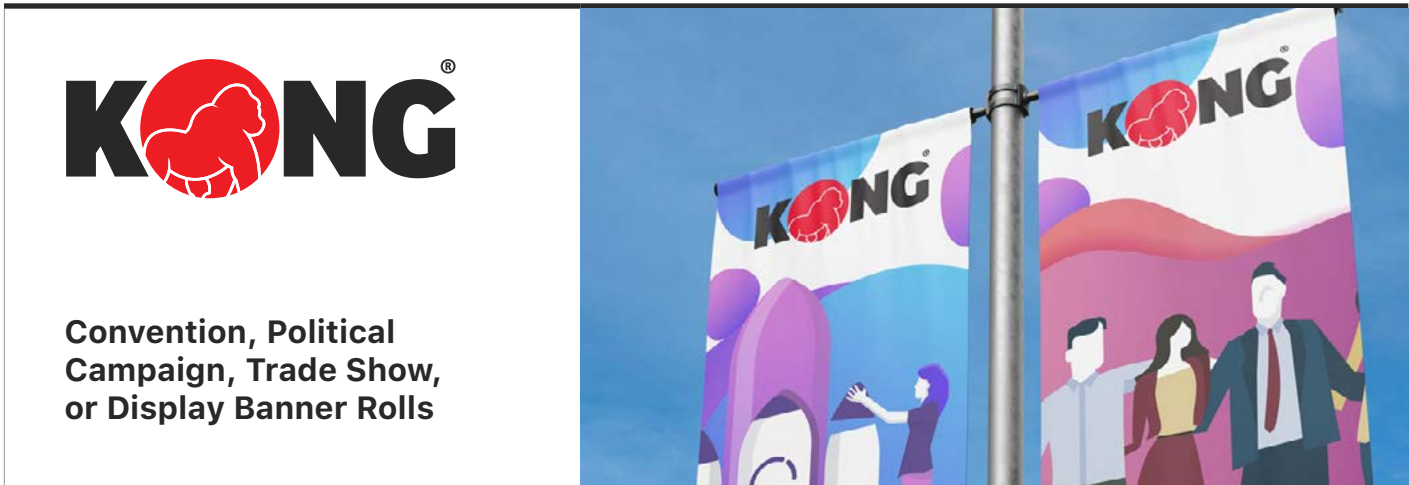

**Convention, Political Campaign, Trade Show, or Display Banner Rolls**

| Key Features |              |        | Available Sizes |     |     |     |     |     |     |     |     |     |     |     |     |      |      |      |      | Item # |  |          |
|--------------|--------------|--------|-----------------|-----|-----|-----|-----|-----|-----|-----|-----|-----|-----|-----|-----|------|------|------|------|--------|--|----------|
| Weight (oz)  | Type         | Finish | 30"             | 38" | 42" | 48" | 50" | 54" | 60" | 63" | 72" | 78" | 80" | 86" | 98" | 102" | 106" | 126" | 150" | 196"   |  |          |
| 8            | Mesh         | Matte  |                 |     |     |     |     |     |     |     |     |     |     |     |     |      |      |      |      |        |  | BN8PSO   |
| 8            | Mesh         | Matte  |                 |     |     |     |     |     |     |     |     |     |     |     |     |      |      |      |      |        |  | BN8PSO   |
| 11           | Fire R. Mesh | Matte  |                 |     |     |     |     |     |     |     |     |     |     |     |     |      |      |      |      |        |  | BN11PSO  |
| 12           | PET          | Matte  |                 |     |     |     |     |     |     |     |     |     |     |     |     |      |      |      |      |        |  | BN12PSO  |
| 13           | Scrim        | Gloss  |                 |     |     |     |     |     |     |     |     |     |     |     |     |      |      |      |      |        |  | BN13PSO  |
| 13           | Scrim        | Matte  |                 |     |     |     |     |     |     |     |     |     |     |     |     |      |      |      |      |        |  | BN13PSO  |
| 8            | Scrim        | Matte  |                 |     |     |     |     |     |     |     |     |     |     |     |     |      |      |      |      |        |  | BN13PSO  |
| 13           | Blockout     | Matte  |                 |     |     |     |     |     |     |     |     |     |     |     |     |      |      |      |      |        |  | BNBO132S |
| 15           | Blockout     | Matte  |                 |     |     |     |     |     |     |     |     |     |     |     |     |      |      |      |      |        |  | BNBO152S |
| 18           | Blockout     | Matte  |                 |     |     |     |     |     |     |     |     |     |     |     |     |      |      |      |      |        |  | BNBO182S |

| Key Features |              |        | Available Sizes |           |           |           |           |           |           |           |           |           |           |           |           |           |           |           |           | Item #     |            |            |            |            |            |            |            |            |            |            |     |                         |
|--------------|--------------|--------|-----------------|-----------|-----------|-----------|-----------|-----------|-----------|-----------|-----------|-----------|-----------|-----------|-----------|-----------|-----------|-----------|-----------|------------|------------|------------|------------|------------|------------|------------|------------|------------|------------|------------|-----|-------------------------|
| Weight (oz.) | Type         | Finish | 24" x 40'       | 36" x 40' | 42" x 40' | 54" x 40' | 60" x 40' | 24" x 60' | 36" x 60' | 42" x 60' | 44" x 60' | 50" x 60' | 54" x 60' | 60" x 60' | 24" x 75' | 36" x 75' | 42" x 75' | 44" x 75' | 50" x 75' | 24" x 100' | 36" x 100' | 42" x 100' | 44" x 100' | 50" x 100' | 54" x 100' | 60" x 100' | 24" x 150' | 36" x 150' | 50" x 150' | 60" x 150' |     |                         |
| 11           | Polyethylene | Matte  |                 |           |           |           |           |           |           |           |           |           |           |           | ✓         | ✓         | ✓         | ✓         | ✓         |            |            |            |            |            |            |            |            |            |            |            |     | 1480 - Banner Tuff      |
| 8            | Polyethylene | Matte  |                 |           |           |           |           |           |           |           |           |           |           |           |           |           |           |           |           | ✓          | ✓          | ✓          | ✓          | ✓          | ✓          | ✓          |            |            |            |            |     | 1554 - WF Poly Pro      |
| 15           | PVC          | Matte  | ✓               | ✓         | ✓         | ✓         | ✓         |           |           |           |           |           |           |           |           |           |           |           |           |            |            |            |            |            |            |            |            |            |            |            |     | 1540 - WF Smooth Scrim  |
| 14           | PVC          | Matte  |                 |           |           |           | ✓         | ✓         | ✓         | ✓         | ✓         | ✓         | ✓         | ✓         |           |           |           |           |           |            |            |            |            |            |            |            |            |            |            |            |     | 1650 - WF NRV Banner    |
| 9            | Polyester    | Matte  |                 |           |           |           |           |           |           |           |           |           |           |           |           |           |           |           |           |            |            |            |            |            |            |            | ✓          | ✓          | ✓          | ✓          |     | 1789 - Heavy Poly Cloth |
| 15           | PVC          | Matte  |                 |           |           |           | ✓         | ✓         | ✓         | ✓         |           |           |           | ✓         |           |           |           |           |           |            |            |            |            |            |            |            |            |            |            |            |     | BN15                    |
| 8            | Polyethylene | Matte  |                 |           |           |           |           |           |           |           |           |           |           |           |           |           |           |           |           | ✓          | ✓          | ✓          |            | ✓          | ✓          |            |            |            |            |            | FM8 |                         |





FILM ROLLS



Quality Clear  
Polyester  
Film Rolls



| Key Features    |                 |             | Available Sizes |           |           |           |           |            |            |            |            |            | Item #                         |
|-----------------|-----------------|-------------|-----------------|-----------|-----------|-----------|-----------|------------|------------|------------|------------|------------|--------------------------------|
| Thickness (mil) | Material        | Finish      | 24" x 75'       | 36" x 75' | 42" x 75' | 50" x 75' | 60" x 75' | 36" x 100' | 42" x 100' | 50" x 100' | 54" x 100' | 60" x 100' |                                |
| 5               | Polyester       | Gloss       |                 |           |           |           |           | ✓          | ✓          | ✓          | ✓          | ✓          | 1221 - Instant Dry Poly        |
| 4               | Polyester       | Clear       | ✓               | ✓         | ✓         | ✓         | ✓         |            |            |            |            |            | 1389 - Clear Film              |
| 9               | Polyester       | Non-Glare   |                 |           |           |           |           | ✓          | ✓          | ✓          | ✓          | ✓          | 1400 - Fast Dry Backlit        |
| 7               | Polyester       | Satin Matte |                 |           |           |           |           | ✓          | ✓          | ✓          | ✓          | ✓          | 1565 - SBL-7 Backlight         |
| 12.5            | Polyester       | Matte       |                 |           |           |           |           | ✓          |            | ✓          |            |            | 1710 - Hydrojet Display        |
| 12.5            | Polyester       | Gloss       |                 |           |           |           |           | ✓          | ✓          |            |            |            | 1730 - Hydrojet Display        |
| 8               | Polyester       | Clear       |                 |           |           |           |           | ✓          |            |            | ✓          | ✓          | 5520 - Solvent Backlit Film    |
| 5               | Polyester       | Gloss       |                 |           |           |           |           | ✓          | ✓          | ✓          |            | ✓          | S5523 - Instant Dry Poly Gloss |
| 7               | Gray Back Vinyl | Matte       |                 |           |           |           |           | ✓          | ✓          | ✓          |            |            | 5550 - SolMatte 7              |
| 12              | Gray Back Vinyl | Matte       |                 |           |           |           |           | ✓          |            | ✓          |            |            | 5555 - SolMatte 12             |
| 6               | Gray Back Vinyl | Gloss       |                 |           |           |           |           | ✓          | ✓          | ✓          |            |            | 5560 - SolGloss 7              |
| 12              | Gray Back Vinyl | Gloss       |                 |           |           |           |           | ✓          |            | ✓          |            |            | 5565 - SolGloss 12             |
| 7               | Textured Vinyl  | Satin       |                 |           |           |           |           | ✓          |            | ✓          |            |            | 5571 - Satin Lightblock        |
| 9               | Textured Vinyl  | Satin       |                 |           |           |           |           | ✓          |            | ✓          |            | ✓          | 5573 - Satin Lightblock        |
| 15              | Textured Vinyl  | Satin       |                 |           |           |           |           | ✓          |            | ✓          |            |            | 5569 - Satin Lightblock        |

# CANVAS PRODUCTS

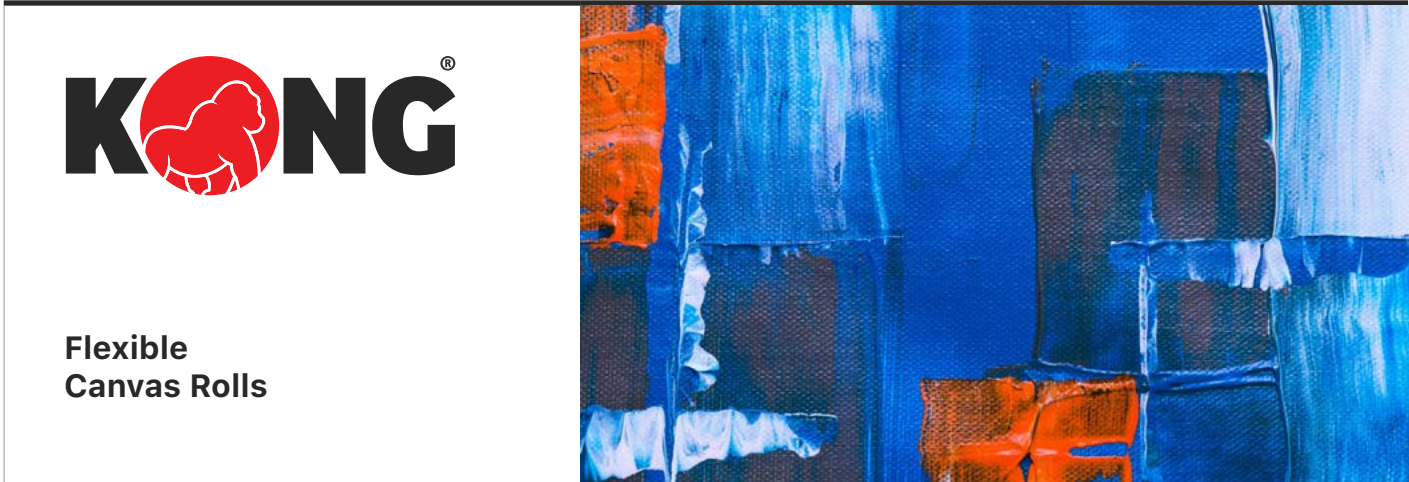

| Key Features    |        |             |        | Available Sizes |           |           |           |           |           |           |           |           |           |           |           |           |           |           |            | Item #     |            |            |                       |
|-----------------|--------|-------------|--------|-----------------|-----------|-----------|-----------|-----------|-----------|-----------|-----------|-----------|-----------|-----------|-----------|-----------|-----------|-----------|------------|------------|------------|------------|-----------------------|
| Thickness (mil) | Weight | Material    | Finish | 17" x 40'       | 24" x 40' | 36" x 40' | 44" x 40' | 50" x 40' | 60" x 40' | 24" x 50' | 36" x 50' | 44" x 50' | 50" x 50' | 60" x 50' | 24" x 75' | 36" x 75' | 44" x 75' | 60" x 75' | 36" x 150' | 42" x 150' | 54" x 150' | 60" x 150' |                       |
| 19              | 360g   | Poly/Blend  | Gloss  |                 |           |           |           |           |           | ✓         | ✓         | ✓         | ✓         | ✓         |           |           |           |           |            |            |            |            | 1269 - Fine Art Gloss |
| 18              | 280g   | Polyester   | Matte  | ✓               | ✓         | ✓         | ✓         | ✓         | ✓         |           |           |           |           |           | ✓         | ✓         | ✓         | ✓         |            |            |            |            | 1512 - Polyester      |
| 22              | 470g   | Poly/Cotton | Matte  |                 | ✓         | ✓         | ✓         | ✓         | ✓         |           |           |           |           |           |           |           |           |           |            |            |            |            | 1530 - Fine Art Matte |
| 8               | 80g    | Poly Cloth  | Matte  |                 |           |           |           |           |           |           |           |           |           |           |           |           |           |           | ✓          | ✓          |            | ✓          | 1780 - Poly Cloth     |
| 21              | 11 oz  | Poly-Cotton | Matte  |                 |           |           |           |           |           |           |           |           |           |           |           |           |           |           |            |            | ✓          | ✓          | 5980 - Matte Artist   |
| 21              | 11 oz  | Poly-Cotton | Gloss  |                 |           |           |           |           |           |           |           |           |           |           |           |           |           |           |            |            | ✓          | ✓          | 5984 -Gloss Artist    |



## MOUNTING FILMS



**Ideal For Indoor And Outdoor Signage Mounting Film Rolls**



| Key Features    |            |           |       |                   | Application Areas |                  |         |                   | Available Sizes |             |             |             |             | Item #      |       |
|-----------------|------------|-----------|-------|-------------------|-------------------|------------------|---------|-------------------|-----------------|-------------|-------------|-------------|-------------|-------------|-------|
| Thickness (mil) | Film Type  | Finish    | Color | Durability (year) | Outdoor Signs     | POP / Trade Show | Windows | Mounting Adhesive | 48" x 25 yd     | 31" x 50 yd | 38" x 50 yd | 51" x 50 yd | 54" x 50 yd | 60" x 50 yd |       |
| 1               | Polyester  | Optically | Clear | 1                 | ●                 | ●                |         | ●                 |                 |             | ✓           | ✓           | ✓           |             | GF106 |
| 1.5             | Polyester  | Opaque    | White | 1                 |                   |                  | ●       | ●                 |                 | ✓           | ✓           | ✓           | ✓           | ✓           | GF107 |
| 0.5             | Polyester  | Gloss     | Clear | 1                 |                   |                  | ●       | ●                 |                 |             | ✓           | ✓           | ✓           |             | GF112 |
| 1               | Polyester  | Gloss     | Clear | 6m                | ●                 | ●                | ●       | ●                 |                 |             | ✓           | ✓           | ✓           |             | GF113 |
| 1               | Polyester  | Gloss     | Clear | 1                 | ●                 | ●                | ●       | ●                 | ✓               |             |             | ✓           | ✓           |             | GF114 |
| 1               | Calendered | Gloss     | Clear | 1                 | ●                 | ●                | ●       | ●                 |                 |             |             |             | ✓           |             | GF116 |



| Key Features    |               |        |          | Available Sizes |            |            |            |            |            |            |            | Item #     |                                     |
|-----------------|---------------|--------|----------|-----------------|------------|------------|------------|------------|------------|------------|------------|------------|-------------------------------------|
| Thickness (mil) | Material      | Finish | Adhesive | 25" x 150'      | 38" x 150' | 43" x 150' | 51" x 150' | 54" x 150' | 61" x 150' | 38" x 200' | 51" x 200' | 61" x 200' |                                     |
| 1               | Mounting Film | Clear  | 2 sides  |                 |            |            |            |            |            | ✓          | ✓          | ✓          | 4001 - Crystal Clear Mount          |
| 1               | Window Mount  | Clear  | Single   |                 | ✓          |            | ✓          | ✓          |            |            |            |            | 4020 - Clear Removable Window Mount |
| 3.2             | Window Film   | Clear  | 2 sides  |                 |            |            |            | ✓          |            |            |            |            | 4090 - Air Egress Window Film       |
| 3               | Mounting Film | Clear  | 2 sides  | ✓               | ✓          | ✓          | ✓          | ✓          | ✓          |            |            |            | 4165 - Milano Mount White           |
| 3               | Mounting Film | Clear  | 2 sides  | ✓               | ✓          | ✓          | ✓          | ✓          | ✓          |            |            |            | 4189 - Milano Mount Clear           |

## ART PAPERS & PHOTO PAPERS



**Gallery Grade  
Fine Art Photo  
and Paper Rolls**



### Art Papers

| Key Features |           |          |       | Available Sizes |           |           |           | Item #            |
|--------------|-----------|----------|-------|-----------------|-----------|-----------|-----------|-------------------|
| Weight       | Type      | Finish   | Color | 24" x 50'       | 36" x 50' | 44" x 50' | 50" x 50' |                   |
| 300g         | Cellulose | Textured | White | ✓               | ✓         | ✓         | ✓         | 2261 - Watercolor |
| 325g         | Art       | Textured | White | ✓               | ✓         | ✓         | ✓         | 2271 - Art Paper  |

### Photo Paper Rolls

| Key Features |              |        |       |           | Available Sizes |            |            |            |            | Item #             |
|--------------|--------------|--------|-------|-----------|-----------------|------------|------------|------------|------------|--------------------|
| Thickness    | Type         | Finish | Color | Core Size | 24" x 100'      | 36" x 100' | 42" x 100' | 50" x 100' | 60" x 100' |                    |
| 5 mil.       | Standard     | Gloss  | White | 2"        |                 | ✓          |            | ✓          | ✓          | MPG5 - Photo Paper |
| 8 mil.       | Professional | Gloss  | White | 2"        | ✓               | ✓          | ✓          | ✓          | ✓          | MPG8 - Photo Paper |
| 8 mil.       | Professional | Satin  | White | 2"        | ✓               | ✓          | ✓          | ✓          | ✓          | MPS8 - Photo Paper |



## WINDOW FILMS



### Etched Glass Film Rolls



Specialty Effect films are specialty vinyl film that provide the look of real etched glass at a fraction of the cost by eliminating the need for sandblasting. For use on architectural door, window and other flat applications.

#### Diffuser



147



148



#### Etchmark



861

#### Frosted



862

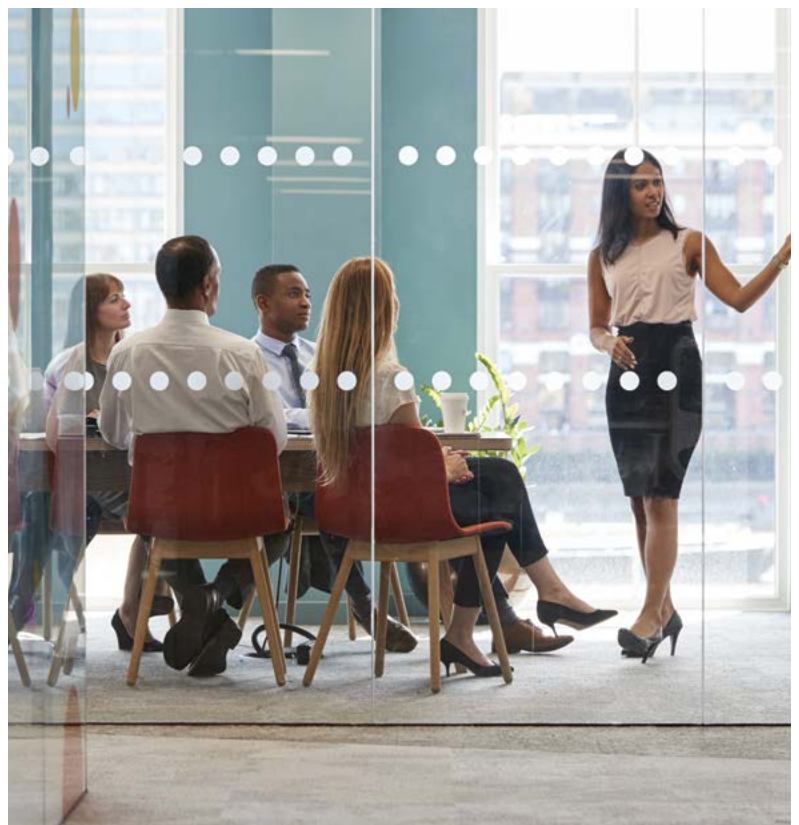

#### Flat / General Formulations



GF207



GF208



GF255

## ONE-WAY VISION PRINTABLE VINYL



**Outside Mount, Perforated,  
One-Way Vision Film  
Outdoor**



| Key Features |                 |         |                   | Application Areas |                  |         | Available Sizes |             |             |             |             |             |             |             | Item #   |
|--------------|-----------------|---------|-------------------|-------------------|------------------|---------|-----------------|-------------|-------------|-------------|-------------|-------------|-------------|-------------|----------|
| Film Type    | Thickness (mil) | Opacity | Durability (year) | Vehicle Wraps     | POP / Trade Show | Windows | 27" x 10 yd     | 27" x 25 yd | 27" x 50 yd | 36" x 10 yd | 36" x 50 yd | 54" x 10 yd | 54" x 25 yd | 54" x 50 yd |          |
| Cast         | 4               | 60/40   | 2                 | ●                 | ●                | ●       |                 |             |             | ✓           | ✓           | ✓           | ✓           | ✓           | 8170-p40 |
| Cast         | 4               | 50/50   | 2                 | ●                 | ●                | ●       |                 |             |             | ✓           | ✓           | ✓           | ✓           | ✓           | 8170-p50 |
| Calendered   | 5.9             | 60/40   | 1                 | ●                 | ●                | ●       | ✓               | ✓           | ✓           |             |             |             |             |             | IJ67     |



| Key Features |                 |         |        | Application Areas |               |                  |         | Available Sizes |           |            |            |            | Item #             |
|--------------|-----------------|---------|--------|-------------------|---------------|------------------|---------|-----------------|-----------|------------|------------|------------|--------------------|
| Film Type    | Thickness (mil) | Opacity | Finish | Durability (year) | Outdoor Signs | POP / Trade Show | Windows | 30" x 30'       | 54" x 30' | 30" x 100' | 54" x 100' | 60" x 100' |                    |
| Calendered   | 6               | 80/20   | White  | 3                 | ●             | ●                | ●       |                 | ✓         |            | ✓          | ✓          | 1520 PanoRama      |
| Calendered   | 6               | 70/30   | White  | 3                 | ●             | ●                | ●       |                 | ✓         |            | ✓          | ✓          | 1530 PanoRama      |
| Calendered   | 6               | 60/40   | White  | 3                 | ●             | ●                | ●       |                 |           |            | ✓          |            | 1540 PanoRama      |
| Calendered   | 6               | 80/20   | White  | 3                 | ●             | ●                | ●       | ✓               | ✓         | ✓          | ✓          | ✓          | 1550 PanoRama      |
| Calendered   | 6               | 50/50   | White  | 3                 |               |                  | ●       |                 |           |            | ✓          | ✓          | 5533 - Innova 50uv |
| Calendered   | 6               | 60/40   | White  | 3                 |               |                  | ●       |                 |           |            | ✓          |            | 5537 - Innova 40uv |
| Calendered   | 6               | 70/30   | White  | 3                 |               |                  | ●       |                 |           |            | ✓          |            | 5542 - Innova 30uv |



**One-Way Vision Printable Vinyl**



| Key Features |                 |         |                   |           | Application Areas |                  |         | Size        | Item #  |
|--------------|-----------------|---------|-------------------|-----------|-------------------|------------------|---------|-------------|---------|
| Film Type    | Thickness (mil) | Opacity | Durability (year) | Adhesive  | Vehicle Wraps     | POP / Trade Show | Windows | 54" x 25 yd |         |
| Calendered   | 7               | 50/50   | 3                 | Removable | ●                 | ●                | ●       | ✓           | MPI2528 |
| Calendered   | 7               | 70/30   | 3                 | Removable | ●                 | ●                | ●       | ✓           | MPI2728 |



| Key Features |                 |         |        |       | Application Areas |               |                  |         |       | Available Sizes |            |             |             | Item # |
|--------------|-----------------|---------|--------|-------|-------------------|---------------|------------------|---------|-------|-----------------|------------|-------------|-------------|--------|
| Film Type    | Thickness (mil) | Opacity | Finish | Color | Durability (year) | Outdoor Signs | POP / Trade Show | Windows | Walls | 54" x 8 yd      | 60" x 8 yd | 54" x 30 yd | 60" x 30 yd |        |
| Calendered   | 6               | 60/40   | Matte  | White | 2                 | ●             | ●                | ●       |       | ✓               | ✓          | ✓           | ✓           | GF260  |
| Calendered   | 6               | 60/40   | Gloss  | Clear | 2                 | ●             | ●                |         | ●     |                 |            | ✓           | ✓           | GF261  |
| Calendered   | 6               | 70/30   | Matte  | White | 2                 |               | ●                | ●       |       | ✓               | ✓          | ✓           | ✓           | GF270  |
| Calendered   | 6               | 80/20   | Matte  | White | 2                 |               | ●                | ●       |       | ✓               | ✓          | ✓           | ✓           | GF280  |



| Key Features |                 |         | Application Areas |                  |         | Available Sizes |              |              |              | Item #           |
|--------------|-----------------|---------|-------------------|------------------|---------|-----------------|--------------|--------------|--------------|------------------|
| Film Type    | Thickness (mil) | Opacity | Vehicle Wraps     | POP / Trade Show | Windows | 54" x 100 yd    | 54" x 300 yd | 36" x 100 yd | 60" x 100 yd |                  |
| Calendered   | 7               | 60/40   | ●                 | ●                | ●       |                 |              |              | ✓            | PSA Single Liner |
| Calendered   | 7               | 60/40   | ●                 | ●                | ●       | ✓               | ✓            |              | ✓            | PSA Dual Liner   |
| Calendered   | 7               | 70/30   | ●                 | ●                | ●       | ✓               |              |              | ✓            | PSA Single Liner |
| Calendered   | 7               | 70/30   | ●                 | ●                | ●       | ✓               |              | ✓            | ✓            | PSA Dual Liner   |
| Calendered   | 7               | 80/20   | ●                 | ●                | ●       |                 |              |              | ✓            | PSA Dual Liner   |



# INK CARTRIDGES TONER & PRINT HEADS



**Ink Cartridges**  
more options available,  
contact us for more details



**HP Designjet  
1050/1055**

- Black MI8600-B
- Cyan MI8601-CY
- Magenta MI8602-MG
- Yellow MI8603-Y



**HP Designjet  
5000/5500 Dye**

- Black MI8620-B
- Cyan MI8621-CY
- Magenta MI8622-MG
- Yellow MI8623-YE
- Light Cyan MI8624-CY
- Light Magenta MI8625-MG



**HP Designjet  
5000/5500 UV**

- Black MI8640-B
- Cyan MI8641-CY
- Magenta MI8642-MG
- Yellow MI8643-YE
- Light Cyan MI8644-CY
- Light Magenta MI8645-MG



**HP Designjet  
70/100/110**

- Black MI8650-B



**HP Designjet  
510**

- Cyan MI8651-CY
- Yellow MI8653-YE



**HP Designjet  
500/800/815/820**

- Magenta MI8652-MG



**HP Designjet  
T1100/T1120/T1200  
T1300/T2300**

- Matte Black MI8680-MB
- Cyan MI8682-CY
- Magenta MI8683-MG



**HP Designjet  
Z6100**

- Photo Black MI8670-B
- Cyan MI8671-CY
- Magenta MI8672-MG
- Yellow MI8673-YE
- Light Cyan MI8674-CY
- Light Magenta MI8675-MG
- Light Gray MI8676-LTG
- Matte Black MI8677-MB



**HP 90  
Milano**

- Black MI8660-B
- Cyan MI8660-CY
- Magenta MI8662-MG
- Yellow MI8662-YE



**HP 771A  
Milano**

- Matte Black MI8690-MB
- Chromatic Red MI8691-RD
- Magenta MI8692-MG
- Yellow MI8693-YE
- Light Magenta MI8694-MG
- Light Cyan MI8695-CY
- Photo Black MI8696-B
- Light Gray MI8697-LG

**! Our Remanufactured HP Ink Cartridges** is our high-quality yet affordable answer to overpriced OEM cartridges.







# Understanding Film Types

Mbs-signsupply help you understand the different film types for ease and accuracy of your graphic film selection.



## Cast Films

Cast films are premium vinyl films that offer the greatest flexibility and conformability for complex surfaces. These films are typically the best option for medium and long-term application.



## Calendered Films

Calendered films are an intermediate vinyl film for short-term applications and less complex surfaces, such as flat or simple curves.

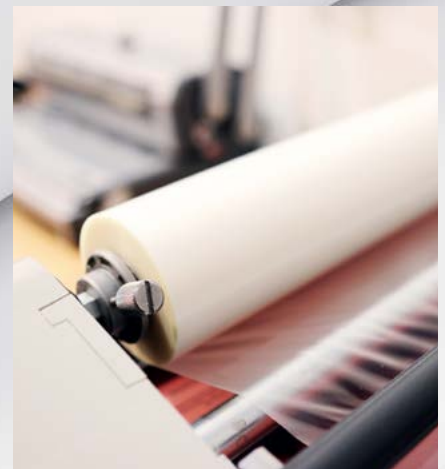

## Overlaminates

Overlaminates are clear, protective films that increase the durability of a printed graphic. The overlaminate makes the film slightly thicker, which helps with installation and removal efficiency. Overlaminates can also provide additional benefits or effects, such as giving color an extra gloss or sparkle finish.



# Vinyl & Application Tapes



## **CAST, INTERMEDIATE & CALENDERED SIGN FILMS**

|                |    |
|----------------|----|
| 3M             | 28 |
| Avery Dennison | 32 |
| Lumina         | 36 |

## **BLOCK-OUT FILMS**

|                |    |
|----------------|----|
| 3M             | 43 |
| Avery Dennison | 44 |

## **TRANSLUCENT FILMS**

|                |    |
|----------------|----|
| 3M             | 45 |
| Avery Dennison | 47 |
| Lumina         | 49 |

## **REFLECTIVE FILMS**

|        |    |
|--------|----|
| 3M     | 50 |
| Lumina | 51 |

## **SPECIALTY FILMS**

|                |    |
|----------------|----|
| Lumina         | 52 |
| RTapes         | 53 |
| Avery Dennison | 53 |

## **FLUORESCENT FILMS**

|                |    |
|----------------|----|
| Avery Dennison | 54 |
|----------------|----|

## **TACK TRANSFER TAPES**

|                |    |
|----------------|----|
| Transferite    | 55 |
| RTape          | 55 |
| Avery Dennison | 56 |

## **PAINT MASK FILMS**

|                |    |
|----------------|----|
| Avery Dennison | 57 |
| Lumina         | 57 |

**CAST, INTERMEDIATE & CALENDERED SIGN FILMS**



**7125, 7725, 7175, 7775  
Graphic Film Series**



| Area of Use  | Common Applications  | Durability | Dimensions  |
|--|--|------------|---|
| <ul style="list-style-type: none"> <li>- Flat Surfaces</li> <li>- Simple Curves</li> <li>- Indoor &amp; Outdoor</li> </ul> | <ul style="list-style-type: none"> <li>- Signage</li> <li>- Crafting</li> <li>- Vehicles</li> <li>- Banners</li> </ul> | - 7 years  | Width<br>24", 48", 60"<br>Length<br>50 yd, 100 yd, 200 yd, 250 yd |

|                         |                       |                             |                       |                         |                        |                        |                        |                        |                        |
|-------------------------|-----------------------|-----------------------------|-----------------------|-------------------------|------------------------|------------------------|------------------------|------------------------|------------------------|
|                         |                       |                             |                       |                         |                        |                        |                        |                        |                        |
| 010<br>White            | 020<br>Matte<br>White | 090<br>Antique<br>White     | 011<br>Pearl<br>Gray  | 121<br>Light<br>Gray    | 031<br>Medium<br>Gray  | 091<br>Dove<br>Gray    | 061<br>Mid<br>Gray     | 151<br>Traffic<br>Gray | 041<br>Dark<br>Gray    |
|                         |                       |                             |                       |                         |                        |                        |                        |                        |                        |
| 101<br>Nimbus<br>Gray   | 012<br>Black          | 022<br>Matte<br>Black       | 069<br>Duranodic      | 019<br>Deep<br>Mahogany | 029<br>Russet<br>Brown | 131<br>Satin<br>Gold   | 059<br>Putty           | 081<br>Stone<br>Gray   | 089<br>Sandstone       |
|                         |                       |                             |                       |                         |                        |                        |                        |                        |                        |
| 039<br>Tan              | 049<br>Beige          | 099<br>Fawn                 | 065<br>Light<br>Lemon | 015<br>Bright<br>Lemon  | 025<br>Sunflower       | 064<br>Apricot         | 105<br>Harvest<br>Gold | 024<br>Terra<br>Cotta  | 054<br>Light<br>Orange |
|                         |                       |                             |                       |                         |                        |                        |                        |                        |                        |
| 014<br>Bright<br>Orange | 074<br>Red<br>Orange  | 263<br>Perfect<br>Match Red | 013<br>Tomato<br>Red  | 293<br>Atomic<br>Red    | 063<br>Geranium        | 053<br>Cardinal<br>Red | 023<br>Deep<br>Red     | 093<br>Imperial<br>Red | 058<br>Burgundy        |
|                         |                       |                             |                       |                         |                        |                        |                        |                        |                        |
| 193<br>Mauve            | 103<br>Magenta        | 273<br>Process<br>Magenta   |                       |                         |                        |                        |                        |                        |                        |



Cast, Intermediate & Calendered Sign Films



**180MC  
Graphic Film Series**



| Area of Use | Common Applications | Durability | Dimensions |
|-------------|---------------------|------------|------------|
|-------------|---------------------|------------|------------|

- Flat Surfaces
- Compound Curves
- Simple Curves
- Indoor & Outdoor

- Signage
- Crafting
- Vehicles
- Banners

- 7 years

Width  
24", 36", 48"  
Length  
50 yd, 100 yd



|                       |             |               |                        |               |                     |                      |                     |                       |                         |
|-----------------------|-------------|---------------|------------------------|---------------|---------------------|----------------------|---------------------|-----------------------|-------------------------|
| 098<br>Dark<br>Violet | 078<br>Plum | 048<br>Purple | 038<br>Royal<br>Purple | 027<br>Indigo | 127<br>Boat<br>Blue | 197<br>Light<br>Navy | 397<br>Dark<br>Blue | 177<br>Shadow<br>Blue | 037<br>Sapphire<br>Blue |
|-----------------------|-------------|---------------|------------------------|---------------|---------------------|----------------------|---------------------|-----------------------|-------------------------|



|                      |                        |                        |                      |                        |                     |                        |                          |                          |                     |
|----------------------|------------------------|------------------------|----------------------|------------------------|---------------------|------------------------|--------------------------|--------------------------|---------------------|
| 017<br>Vivid<br>Blue | 047<br>Intense<br>Blue | 117<br>Persian<br>Blue | 107<br>Light<br>Blue | 057<br>Olympic<br>Blue | 097<br>Soft<br>Blue | 077<br>Peacock<br>Blue | 187<br>Wedgewood<br>Blue | 086<br>Robin Egg<br>Blue | 307<br>Dark<br>Aqua |
|----------------------|------------------------|------------------------|----------------------|------------------------|---------------------|------------------------|--------------------------|--------------------------|---------------------|



|             |                        |                      |                       |                        |                       |                      |                       |                        |                        |
|-------------|------------------------|----------------------|-----------------------|------------------------|-----------------------|----------------------|-----------------------|------------------------|------------------------|
| 096<br>Teal | 357<br>Bermuda<br>Blue | 136<br>Lime<br>Green | 196<br>Apple<br>Green | 186<br>Bright<br>Green | 046<br>Kelly<br>Green | 056<br>Dark<br>Green | 016<br>Khaki<br>Green | 066<br>Forest<br>Green | 276<br>Bottle<br>Green |
|-------------|------------------------|----------------------|-----------------------|------------------------|-----------------------|----------------------|-----------------------|------------------------|------------------------|

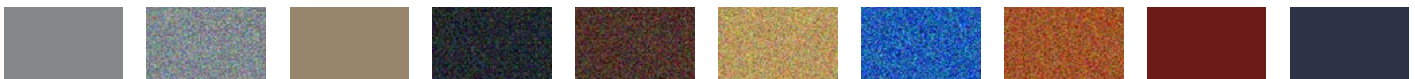

|                          |                          |                              |                             |                                       |                         |                       |                           |                          |     |
|--------------------------|--------------------------|------------------------------|-----------------------------|---------------------------------------|-------------------------|-----------------------|---------------------------|--------------------------|-----|
| 120<br>Satin<br>Aluminum | 201<br>Slate<br>Metallic | 249<br>Champagne<br>Metallic | 211<br>Charcoal<br>Metallic | 239<br>Chocolate<br>Brown<br>Metallic | 241<br>Gold<br>Metallic | 227<br>Bright<br>Blue | 229<br>Copper<br>Metallic | 243<br>Steam<br>Punk Red | 247 |
|--------------------------|--------------------------|------------------------------|-----------------------------|---------------------------------------|-------------------------|-----------------------|---------------------------|--------------------------|-----|



217  
Dark Blue  
Metallic



Cast, Intermediate & Calendered Sign Films



7725 SE  
Graphic Film Series



| Area of Use  | Common Applications  | Durability  | Dimensions                           |
|--|--|---|--------------------------------------|
| <ul style="list-style-type: none"> <li>- Flat Surfaces</li> <li>- Simple Curves</li> <li>- Indoor &amp; Outdoor</li> </ul> | <ul style="list-style-type: none"> <li>- Signage</li> <li>- Crafting</li> <li>- Vehicles</li> <li>- Banners</li> </ul> | <ul style="list-style-type: none"> <li>- 5 years</li> </ul> | Width<br>30", 48"<br>Length<br>50 yd |

|               |               |              |             |                |                      |                          |                           |                        |                        |                        |
|---------------|---------------|--------------|-------------|----------------|----------------------|--------------------------|---------------------------|------------------------|------------------------|------------------------|
|               |               |              |             |                |                      |                          |                           |                        |                        |                        |
| 404<br>Orange | 405<br>Yellow | 406<br>Green | 407<br>Blue | 413<br>Fuchsia | 414<br>Red<br>Orange | 314<br>Dusted<br>Crystal | 324<br>Frosted<br>Crystal | 325<br>Frosted<br>Mint | 327<br>Frosted<br>Mist | 331<br>Frosted<br>Gold |

Scotchcal™ 50 Graphic Film Series

| Area of Use  | Common Applications  | Durability  | Dimensions                      |
|--|--|---|---------------------------------|
| <ul style="list-style-type: none"> <li>- Flat Surfaces</li> <li>- Simple Curves</li> <li>- Indoor &amp; Outdoor</li> </ul> | <ul style="list-style-type: none"> <li>- Signage</li> <li>- Crafting</li> <li>- Vehicles</li> <li>- Banners</li> </ul> | <ul style="list-style-type: none"> <li>- 5 years</li> </ul> | Width<br>48"<br>Length<br>50 yd |

  

|                        |                      |                       |                      |                       |                         |                          |                        |                        |                       |
|------------------------|----------------------|-----------------------|----------------------|-----------------------|-------------------------|--------------------------|------------------------|------------------------|-----------------------|
|                        |                      |                       |                      |                       |                         |                          |                        |                        |                       |
| 011<br>Transparent     | 010<br>White         | 100<br>Matte<br>White | 094<br>Light<br>Gray | 097<br>Nimbus<br>Gray | 058<br>Silver           | 012<br>Black             | 120<br>Matte<br>Black  | 092<br>Brown           | 054<br>Gold           |
|                        |                      |                       |                      |                       |                         |                          |                        |                        |                       |
| 914<br>Beige           | 064<br>Pink          | 044<br>Light<br>Red   | 483<br>Dark<br>Red   | 049<br>Burgundy       | 034<br>Bright<br>Orange | 027<br>Sunflower         | 024<br>Lemon<br>Yellow | 745<br>Bright<br>Green | 073<br>Grass<br>Green |
|                        |                      |                       |                      |                       |                         |                          |                        |                        |                       |
| 076<br>Medium<br>Green | 078<br>Dark<br>Green | 079<br>Teal           | 082<br>Light<br>Blue | 084<br>Azure<br>Blue  | 088<br>Sapphire<br>Blue | 090<br>Deep Navy<br>Blue | 066<br>Purple          |                        |                       |



ORDER ONLINE!  
Available at [mbs-signsupply.com](http://mbs-signsupply.com)

# 3M

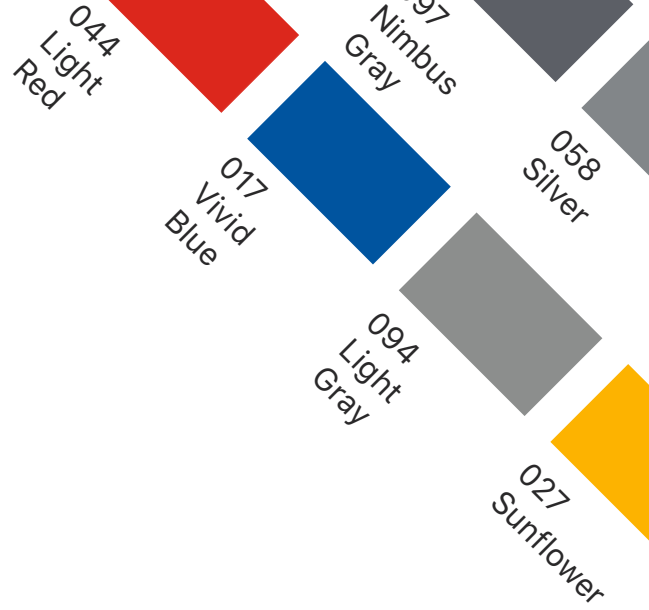

## Achieve a Higher Standard



Graphic Products for  
Every Project.

Allow yourself to dream bigger than ever and take every graphic installation to the next level. Premium graphics help tell brand stories and support other initiatives like maximizing sustainability efforts and increasing sales. 3M products give you the power to go above and beyond the customer's vision and see opportunity on every surface.

Cast, Intermediate & Calendered Sign Films



**HP750**  
**High Performance**  
**Cut Vinyl**







| Area of Use   | Common Applications  | Durability   | Dimensions   |
|---|--|--|--|
| <ul style="list-style-type: none"> <li>- Flat Surfaces</li> <li>- Indoor &amp; Outdoor</li> </ul> | <ul style="list-style-type: none"> <li>- Signage</li> <li>- Crafting</li> <li>- Vehicles</li> <li>- Banners</li> </ul> | <ul style="list-style-type: none"> <li>- Colors Black &amp; White</li> <li>10 years</li> <li>- Clear 103 and Matte</li> <li>Clear 104 2 years</li> </ul> | <p>Width</p> <p>12", 15", 24", 30", 48", 60"</p> <p>Length</p> <p>10 yd, 50 yd</p> |

|       |                           |                       |                               |                         |                           |                       |                            |                        |                          |                      |
|-------|---------------------------|-----------------------|-------------------------------|-------------------------|---------------------------|-----------------------|----------------------------|------------------------|--------------------------|----------------------|
| Gloss |                           |                       |                               |                         |                           |                       |                            |                        |                          |                      |
|       | 101<br>White              | 102<br>Matte<br>White | 103<br>Clear                  | 104<br>Matte<br>Clear   | 105<br>True<br>White      | 108<br>Cover<br>White | 180<br>Matte<br>Black      | 190<br>Gloss<br>Black  | 206<br>Bright<br>Yellow  |                      |
|       |                           |                       |                               |                         |                           |                       |                            |                        |                          |                      |
|       | 210<br>Primrose<br>Yellow | 215<br>Gold           | 220<br>Canary<br>Yellow       | 225<br>Rubber<br>Duckie | 230<br>Medium<br>Yellow   | 235<br>Yellow         | 240<br>Sunflower<br>Yellow | 250<br>Dark<br>Yellow  | 253<br>Imitation<br>Gold | 315<br>Tangerine     |
|       |                           |                       |                               |                         |                           |                       |                            |                        |                          |                      |
|       | 355<br>Apricot            | 360<br>Orange         | 362<br>Construction<br>Orange | 380<br>Bright<br>Orange | 405<br>Hibiscus<br>Red    | 417<br>Real Red       | 418<br>Luminous<br>Red     | 425<br>Tomato<br>Red   | 430<br>Cardinal<br>Red   | 440<br>Red           |
|       |                           |                       |                               |                         |                           |                       |                            |                        |                          |                      |
|       | 445<br>Fire Red           | 450<br>Dark<br>Red    | 460<br>Spectra<br>Red         | 470<br>Burgundy         | 480<br>Burgundy<br>Maroon | 508<br>Soft<br>Pink   | 513<br>Violet              | 515<br>Blossom         | 519<br>Blush             | 530<br>Magenta       |
|       |                           |                       |                               |                         |                           |                       |                            |                        |                          |                      |
|       | 565<br>Purple             | 570<br>Berry          | 575<br>Lavender               | 620<br>Shade<br>Blue    | 625<br>Majestic<br>Blue   | 626<br>French<br>Blue | 628<br>Egyptian<br>Blue    | 630<br>Olympic<br>Blue | 635<br>Nautical<br>Blue  | 640<br>Light<br>Blue |





















## HP750 High Performance Cut Vinyl

|   |   |   |   |   |   |  |   |   |   |
|---|---|---|---|---|---|--|---|---|---|
|    |    |    |    |    |    |    |    |    |    |
| 642<br>Cascade<br>Blue  | 645<br>Peacock<br>Blue  | 650<br>Powder<br>Blue   | 652<br>Butterfly<br>Blue  | 659<br>Byzantine<br>Blue  | 665<br>Medium<br>Blue   | 670<br>Vivid<br>Blue   | 675<br>Interstate<br>Blue   | 678<br>Ocean<br>Blue  | 679<br>Reflex<br>Blue   |
|    |    |    |    |    |    |    |    |    |    |
| 680<br>Sapphire<br>Blue   | 682<br>Impact<br>Blue   | 683<br>Sapphire<br>Blue   | 687<br>Impulse<br>Blue  | 690<br>Light<br>Navy  | 695<br>Dark Blue  | 705<br>Dark Aqua   | 715<br>Real<br>Teal   | 720<br>Teal   | 726<br>Parakeet<br>Green  |
|    |    |    |    |    |    |    |    |    |    |
| 730<br>Dark Teal  | 734<br>Dark<br>Green  | 760<br>Apple<br>Green   | 765<br>Olive<br>Green   | 770<br>Kelly<br>Green   | 772<br>Grow<br>Green  | 775<br>Bright<br>Green   | 778<br>Green  | 780<br>Yellow<br>Green  | 785<br>Forest<br>Green  |
|    |    |    |    |    |    |    |    |    |    |
| 790<br>Deep<br>Green  | 793<br>Dark<br>Green  | 804<br>Pewter   | 810<br>Light<br>Gray  | 817<br>Silver   | 820<br>Palm<br>Oyster   | 825<br>Light Ash<br>Gray   | 830<br>Slate<br>Gray  | 835<br>Medium<br>Gray   | 855<br>Dark<br>Gray   |
|  |  |  |  |  |  |  |  |  |  |
| 870<br>Battleship<br>Gray   | 910<br>Almond   | 920<br>Beige  | 921<br>Dark<br>Beige  | 960<br>Terracotta   | 965<br>Sandstone  | 970<br>Buckskin  | 978<br>Cocoa  | 983<br>Dark<br>Brown  | 990<br>Chocolate<br>Brown   |

## PC500 Promotional Calendered Series

| Area of Use  | Common Applications  | Durability | Dimensions                                     |
|--|--|------------|--|
| <ul style="list-style-type: none"> <li>- Flat Surfaces</li> <li>- Indoor &amp; Outdoor</li> <li>- Simple Curves</li> </ul> | <ul style="list-style-type: none"> <li>- Signage</li> <li>- Crafting</li> <li>- Vehicles</li> <li>- Banners</li> </ul> | - 2 years  | Width<br>15", 24", 30", 48"<br>Length<br>50 yd |

|   |   |   |   |   |   |  |   |   |   |
|---|---|---|---|---|---|--|---|---|---|
| High Gloss  |  |  |  |  |  |  |  |  |  |
|   | 101<br>White  | 102<br>White<br>ReadyCal  | 103<br>Clear  | 190<br>Black  | 209<br>Stone<br>Yellow  | 220<br>Canary<br>Yellow  | 359<br>Pizazz<br>Orange   | 420<br>Cherry<br>Red  | 430<br>Cardinal<br>Red  |
|  |  |  |  |  |  |  |   |   |   |
| 512<br>Tropical<br>Pink   | 662<br>Azure<br>Blue  | 683<br>Royal<br>Blue  | 689<br>Mariner<br>Blue  | 774<br>Mountain<br>Green  | 785<br>Forest<br>Green  | 801<br>Silver  |   |   |   |

Cast, Intermediate & Calendered Sign Films



**SC950  
Supercast Series**



| Area of Use   | Common Applications  | Durability  | Dimensions   |
|---|--|---|--|
| <ul style="list-style-type: none"> <li>- Flat Surfaces</li> <li>- Indoor &amp; Outdoor</li> <li>- Simple Curves</li> <li>- Corrugations</li> <li>- Deep Recesses</li> </ul> | <ul style="list-style-type: none"> <li>- Signage</li> <li>- Crafting</li> <li>- Vehicles</li> <li>- Banners</li> </ul> | Black, White & Clear: 10 Years<br>Colors: 8 Years<br>Metallics (except for #219, 801): 5 Years<br>Metallics, #219 and #801: 3 Years | Width<br>12", 15", 24", 30", 48"<br>Length<br>10 yd, 50 yd |

|                    |                               |                         |                           |                       |                            |                        |                          |                         |                           |
|--------------------|-------------------------------|-------------------------|---------------------------|-----------------------|----------------------------|------------------------|--------------------------|-------------------------|---------------------------|
|                    |                               |                         |                           |                       |                            |                        |                          |                         |                           |
| 101<br>White       | 102<br>Matte<br>White         | 103<br>Clear            | 104<br>Matte<br>Clear     | 105<br>True<br>White  | 108<br>Cover<br>White      | 180<br>Matte<br>Black  | 190<br>Black             | 206<br>Bright<br>Yellow | 210<br>Primrose<br>Yellow |
|                    |                               |                         |                           |                       |                            |                        |                          |                         |                           |
| 215<br>Gold        | 220<br>Canary<br>Yellow       | 225<br>Rubber<br>Duckie | 230<br>Medium<br>Yellow   | 235<br>Yellow         | 240<br>Sunflower<br>Yellow | 250<br>Dark<br>Yellow  | 253<br>Imitation<br>Gold | 315<br>Tangerine        | 355<br>Apricot            |
|                    |                               |                         |                           |                       |                            |                        |                          |                         |                           |
| 360<br>Orange      | 362<br>Construction<br>Orange | 380<br>Bright<br>Orange | 405<br>Hibiscus<br>Red    | 417<br>Real<br>Red    | 418<br>Luminous<br>Red     | 425<br>Tomato<br>Red   | 430<br>Cardinal<br>Red   | 440<br>Red              | 445<br>Fire<br>Red        |
|                    |                               |                         |                           |                       |                            |                        |                          |                         |                           |
| 450<br>Dark<br>Red | 460<br>Spectra<br>Red         | 470<br>Burgundy         | 480<br>Burgundy<br>Maroon | 508<br>Soft Pink      | 513<br>Violet              | 515<br>Blossom         | 519<br>Blush             | 530<br>Magenta          | 565<br>Purple             |
|                    |                               |                         |                           |                       |                            |                        |                          |                         |                           |
| 570<br>Berry       | 575<br>Lavender               | 620<br>Shade<br>Blue    | 625<br>Majestic<br>Blue   | 626<br>French<br>Blue | 628<br>Egyptian<br>Blue    | 630<br>Olympic<br>Blue | 635<br>Nautical<br>Blue  | 640<br>Light<br>Blue    | 642<br>Cascade<br>Blue    |



# SC950 Supercast Series



|                        |                       |                          |                       |                          |                        |                      |                           |                      |                       |
|------------------------|-----------------------|--------------------------|-----------------------|--------------------------|------------------------|----------------------|---------------------------|----------------------|-----------------------|
| 645<br>Peacock<br>Blue | 650<br>Powder<br>Blue | 652<br>Butterfly<br>Blue | 655<br>Medium<br>Blue | 659<br>Byzantine<br>Blue | 665<br>Intense<br>Blue | 670<br>Vivid<br>Blue | 675<br>Interstate<br>Blue | 678<br>Ocean<br>Blue | 679<br>Reflex<br>Blue |
|------------------------|-----------------------|--------------------------|-----------------------|--------------------------|------------------------|----------------------|---------------------------|----------------------|-----------------------|



|                         |                       |                      |                        |                      |                     |                     |                     |             |                          |
|-------------------------|-----------------------|----------------------|------------------------|----------------------|---------------------|---------------------|---------------------|-------------|--------------------------|
| 680<br>Sapphire<br>Blue | 682<br>Impact<br>Blue | 683<br>Royal<br>Blue | 687<br>Impulse<br>Blue | 690<br>Light<br>Navy | 695<br>Dark<br>Blue | 705<br>Dark<br>Aqua | 715<br>Real<br>Teal | 720<br>Teal | 726<br>Parakeet<br>Green |
|-------------------------|-----------------------|----------------------|------------------------|----------------------|---------------------|---------------------|---------------------|-------------|--------------------------|



|                     |                        |                       |                       |                       |                      |                        |              |                        |                        |
|---------------------|------------------------|-----------------------|-----------------------|-----------------------|----------------------|------------------------|--------------|------------------------|------------------------|
| 730<br>Dark<br>Teal | 734<br>Citrus<br>Green | 760<br>Apple<br>Green | 765<br>Olive<br>Green | 770<br>Kelly<br>Green | 772<br>Grow<br>Green | 775<br>Bright<br>Green | 778<br>Green | 780<br>Yellow<br>Green | 785<br>Forest<br>Green |
|---------------------|------------------------|-----------------------|-----------------------|-----------------------|----------------------|------------------------|--------------|------------------------|------------------------|



|                      |                      |               |                      |               |                       |                          |                      |                       |                     |
|----------------------|----------------------|---------------|----------------------|---------------|-----------------------|--------------------------|----------------------|-----------------------|---------------------|
| 790<br>Deep<br>Green | 793<br>Dark<br>Green | 804<br>Pewter | 810<br>Light<br>Gray | 817<br>Silver | 820<br>Palm<br>Oyster | 825<br>Light<br>Ash Gray | 830<br>Slate<br>Gray | 835<br>Medium<br>Gray | 855<br>Dark<br>Gray |
|----------------------|----------------------|---------------|----------------------|---------------|-----------------------|--------------------------|----------------------|-----------------------|---------------------|



|                           |               |              |                   |                       |                  |                 |              |                      |                           |
|---------------------------|---------------|--------------|-------------------|-----------------------|------------------|-----------------|--------------|----------------------|---------------------------|
| 870<br>Battleship<br>Gray | 910<br>Almond | 920<br>Beige | 921<br>Dark Beige | 960<br>Terra<br>Cotta | 965<br>Sandstone | 970<br>Buckskin | 978<br>Cocoa | 983<br>Dark<br>Brown | 990<br>Chocolate<br>Brown |
|---------------------------|---------------|--------------|-------------------|-----------------------|------------------|-----------------|--------------|----------------------|---------------------------|



|                 |                             |              |                          |                       |             |                      |            |                        |                     |
|-----------------|-----------------------------|--------------|--------------------------|-----------------------|-------------|----------------------|------------|------------------------|---------------------|
| <b>Metallic</b> | 109<br>White<br>Pearlescent | 190<br>Black | 207<br>Champaign<br>Mist | 213<br>Bright<br>Gold | 215<br>Gold | 217<br>Light<br>Gold | 441<br>Red | 455<br>Autumn<br>Maple | 641<br>Mist<br>Blue |
|-----------------|-----------------------------|--------------|--------------------------|-----------------------|-------------|----------------------|------------|------------------------|---------------------|



|                       |                         |                      |                           |                      |                        |                           |               |                 |                 |
|-----------------------|-------------------------|----------------------|---------------------------|----------------------|------------------------|---------------------------|---------------|-----------------|-----------------|
| 646<br>Bright<br>Blue | 647<br>Electric<br>Blue | 651<br>Grand<br>Blue | 653<br>Dark Royal<br>Blue | 683<br>Royal<br>Blue | 779<br>Hunter<br>Green | 801<br>Silver<br>Metallic | 804<br>Pewter | 805<br>Charcoal | 806<br>Gunmetal |
|-----------------------|-------------------------|----------------------|---------------------------|----------------------|------------------------|---------------------------|---------------|-----------------|-----------------|



|                           |                         |                        |                             |                          |               |               |
|---------------------------|-------------------------|------------------------|-----------------------------|--------------------------|---------------|---------------|
| 808<br>Medium<br>Charcoal | 809<br>Dark<br>Charcoal | 869<br>Light<br>Silver | 923<br>Light Briar<br>Brown | 928<br>Antique<br>Bronze | 930<br>Bronze | 932<br>Copper |
|---------------------------|-------------------------|------------------------|-----------------------------|--------------------------|---------------|---------------|



|                       |                         |                       |                      |                     |                             |                      |                        |
|-----------------------|-------------------------|-----------------------|----------------------|---------------------|-----------------------------|----------------------|------------------------|
| <b>Ultra Metallic</b> | 160<br>White<br>Sparkle | 195<br>Ultra<br>Black | 219<br>Ultra<br>Gold | 481<br>Ultra<br>Red | 585<br>Ultra Rose<br>Quartz | 779<br>Ultra<br>Blue | 877<br>Ultra<br>Silver |
|-----------------------|-------------------------|-----------------------|----------------------|---------------------|-----------------------------|----------------------|------------------------|



Cast, Intermediate & Calendered Sign Films

# Lumina

by FDC

**2100 / 2200**  
**Premium**  
**Film Rolls**



| Area of Use | Common Applications | Durability | Dimensions |
|-------------|---------------------|------------|------------|
|-------------|---------------------|------------|------------|

- Flat Surfaces
- Indoor & Outdoor
- Simple Curves
- Corrugations

- Signage
- Crafting
- Vehicles
- Banners

- 5 Years

Width  
1/2", 1", 2", 3", 4", 5", 6" 8", 10"  
12", 15", 18", 20", 24", 30", 36"  
39", 48", 60"  
Length  
5 yd, 10 yd, 50 yd

|                          |                       |                           |                          |                         |                             |                               |                       |                          |                       |
|--------------------------|-----------------------|---------------------------|--------------------------|-------------------------|-----------------------------|-------------------------------|-----------------------|--------------------------|-----------------------|
|                          |                       |                           |                          |                         |                             |                               |                       |                          |                       |
| 000<br>Clear             | 300<br>Matte<br>Clear | 002<br>Gloss<br>Matte     | 049<br>Matte<br>White    | 102<br>Crystal<br>White | 122<br>Light<br>Gray        | 327<br>Slate<br>Gray          | 028<br>Dove<br>Gray   | 350<br>Medium<br>Grey    | 210<br>Dark<br>Slate  |
|                          |                       |                           |                          |                         |                             |                               |                       |                          |                       |
| 052<br>Dark<br>Gray      | 040<br>Matte<br>Black | 003<br>Gloss<br>Black     | 208<br>Brown             | 250<br>Sundried         | 174<br>Taupe                | 279<br>Saddle                 | 178<br>Sand<br>Pebble | 068<br>Beige             | 026<br>Oyster         |
|                          |                       |                           |                          |                         |                             |                               |                       |                          |                       |
| 107<br>Almond            | 418<br>Parchment      | 348<br>Camel              | 182<br>Sunbeam<br>Yellow | 331<br>Golden<br>Yellow | 067<br>Primrose<br>Yellow   | 306<br>Yellow                 | 323<br>Dark<br>Yellow | 359<br>Imitation<br>Gold | 180<br>Terra<br>Cotta |
|                          |                       |                           |                          |                         |                             |                               |                       |                          |                       |
| 448<br>Pumpkin<br>Orange | 009<br>Orange         | 133<br>Tangerine          | 269<br>Warm Red          | 014<br>Tomato<br>Red    | 125<br>Wild<br>Cardinal Red | 060<br>Bright<br>Cardinal Red | 232<br>Fire<br>Red    | 334<br>Apple<br>Red      | 434<br>Spectra<br>Red |
|                          |                       |                           |                          |                         |                             |                               |                       |                          |                       |
| 001<br>Red               | 012<br>Burgundy       | 342<br>Medium<br>Burgundy | 259<br>Wineberry         | 113<br>Salmon<br>Pink   | 276<br>Magenta              | 124<br>Fiesta<br>Pink         | 056<br>Hot<br>Pink    | 058<br>Dark<br>Magenta   | 414<br>Raspberry      |



## Cast, Intermediate & Calendered Sign Films

|                        |                             |                         |                       |                        |                           |                          |                           |                         |                       |
|------------------------|-----------------------------|-------------------------|-----------------------|------------------------|---------------------------|--------------------------|---------------------------|-------------------------|-----------------------|
|                        |                             |                         |                       |                        |                           |                          |                           |                         |                       |
| 135<br>Dark<br>Orchid  | 253<br>Lilac                | 168<br>Plum             | 337<br>Deep<br>Purple | 074<br>Royal<br>Purple | 325<br>Copenhagen<br>Blue | 011<br>Dark<br>Blue      | 338<br>Light<br>Navy Blue | 239<br>Majestic<br>Blue | 141<br>Shadow<br>Blue |
|                        |                             |                         |                       |                        |                           |                          |                           |                         |                       |
| 305<br>Blue            | 140<br>Intense<br>Blue      | 314<br>Medium<br>Blue   | 132<br>Azure<br>Blue  | 018<br>Olympic<br>Blue | 408<br>Peacock<br>Blue    | 339<br>Wedgewood<br>Blue | 252<br>Sea                | 316<br>Dark<br>Aqua     | 117<br>Real<br>Teal   |
|                        |                             |                         |                       |                        |                           |                          |                           |                         |                       |
| 171<br>Teal            | 353<br>Dark<br>Bahama Blue  | 374<br>Vibrant<br>Green | 257<br>Lime<br>Green  | 069<br>Apple<br>Green  | 181<br>Willow<br>Green    | 061<br>Kelly<br>Green    | 126<br>Emerald<br>Green   | 106<br>Medium<br>Green  | 324<br>Dark<br>Green  |
|                        |                             |                         |                       |                        |                           |                          |                           |                         |                       |
| 142<br>Forest<br>Green | 270<br>Dark Forest<br>Green |                         |                       |                        |                           |                          |                           |                         |                       |



Premium Films

# Lumina

by FDC

2100 / 2200  
Premium Metallic  
Film Rolls

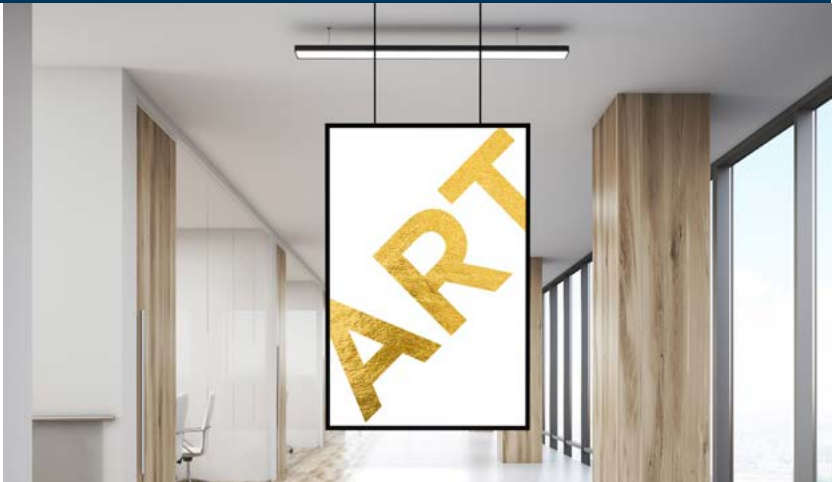

| Area of Use | Common Applications | Durability | Dimensions |
|-------------|---------------------|------------|------------|
|-------------|---------------------|------------|------------|

- Flat Surfaces
- Indoor & Outdoor
- Simple Curves
- Corrugations

- Signage
- Crafting
- Vehicles
- Banners

- 5 Years

Width  
1/4", 3/8", 1/2", 3/4", 1", 2", 3", 4",  
5", 6", 8", 10", 12", 15", 18", 20",  
24", 30", 36", 39", 48", 60"  
Length  
5 yd, 10 yd, 50 yd

|                                  |                                   |                                     |                                  |                                       |                                    |                                    |                                     |                                   |                               |
|----------------------------------|-----------------------------------|-------------------------------------|----------------------------------|---------------------------------------|------------------------------------|------------------------------------|-------------------------------------|-----------------------------------|-------------------------------|
|                                  |                                   |                                     |                                  |                                       |                                    |                                    |                                     |                                   |                               |
| 007<br>Silver<br>Metallic        | 194<br>Pewter<br>Metallic         | 320<br>Charcoal<br>Metallic         | 295<br>Onyx<br>Metallic          | 355<br>Broadway<br>Bronze<br>Metallic | 261<br>Light<br>Brown<br>Metallic  | 287<br>Light<br>Sierra<br>Metallic | 420<br>Copper<br>Metallic           | 318<br>Bright<br>Gold<br>Metallic | 004<br>Gold<br>Metallic       |
|                                  |                                   |                                     |                                  |                                       |                                    |                                    |                                     |                                   |                               |
| 041<br>Light<br>Gold<br>Metallic | 286<br>Champagne<br>Metallic      | 319<br>Red<br>Metallic              | 445<br>Light<br>Rose<br>Metallic | 439<br>Burgundy<br>Metallic           | 360<br>Dark<br>Magenta<br>Metallic | 264<br>Royal<br>Purple<br>Metallic | 165<br>Lavender<br>Metallic         | 289<br>Periwinkle<br>Metallic     | 427<br>Mist Blue<br>Metallic  |
|                                  |                                   |                                     |                                  |                                       |                                    |                                    |                                     |                                   |                               |
| 345<br>Blue<br>Metallic          | 211<br>Bright<br>Blue<br>Metallic | 266<br>Electric<br>Blue<br>Metallic | 030<br>Dark<br>Blue<br>Metallic  | 343<br>Grand<br>Blue<br>Metallic      | 146<br>Steel<br>Blue<br>Metallic   | 291<br>Aquamarine<br>Metallic      | 356<br>Mountain<br>Mist<br>Metallic | 293<br>Seamfoam<br>Metallic       | 450<br>Dark Green<br>Metallic |

3700 / 3750 Premium Ultra-Metallic Vinyl Film

|                     |                        |                 |             |                          |              |                             |              |                     |                      |
|---------------------|------------------------|-----------------|-------------|--------------------------|--------------|-----------------------------|--------------|---------------------|----------------------|
|                     |                        |                 |             |                          |              |                             |              |                     |                      |
| 004<br>Gold         | 007<br>Silver          | 193<br>Seafoam  | 195<br>Onyx | 206<br>Breakfast<br>Blue | 113<br>Coral | 125<br>Wild<br>Cardinal Red | 008<br>Brown | 019<br>Cool<br>Blue | 024<br>Dark<br>Green |
|                     |                        |                 |             |                          |              |                             |              |                     |                      |
| 030<br>Dark<br>Blue | 074<br>Royal<br>Purple | 242<br>Burgundy | 252<br>Mint |                          |              |                             |              |                     |                      |



Intermediate Films

# Lumina

by FDC

**4200 / 4250  
Intermediate  
Film Rolls**



| Area of Use | Common Applications | Durability | Dimensions |
|-------------|---------------------|------------|------------|
|-------------|---------------------|------------|------------|

- Flat Surfaces
- Indoor & Outdoor
- Simple Curves
- Corrugations

- Signage
- Crafting
- Vehicles
- Banners

- 5 Years

Width  
1/4", 3/8", 1/2", 3/4", 1", 2", 3", 4",  
5", 6", 8", 10", 12", 15", 18", 20",  
24", 30", 36", 39", 48", 54", 60"  
Length  
5 yd, 10 yd, 50 yd

|                        |                         |                                |                         |                          |                         |                           |                        |                          |                      |
|------------------------|-------------------------|--------------------------------|-------------------------|--------------------------|-------------------------|---------------------------|------------------------|--------------------------|----------------------|
|                        |                         |                                |                         |                          |                         |                           |                        |                          |                      |
| 000<br>Clear           | 200<br>Matte<br>Clear   | 002<br>Gloss<br>White          | 049<br>Matte<br>White   | 202<br>Restful<br>White  | 102<br>Crystal<br>White | 007<br>Silver             | 050<br>Medium<br>Gray  | 003<br>Gloss<br>Black    | 268<br>Flat<br>Black |
|                        |                         |                                |                         |                          |                         |                           |                        |                          |                      |
| 040<br>Matte<br>Black  | 008<br>Brown            | 004<br>Gold                    | 068<br>Beige            | 182<br>Sunbeam<br>Yellow | 080<br>Matte<br>Yellow  | 067<br>Primrose<br>Yellow | 025<br>Sunflower       | 006<br>Yellow            | 113<br>Coral         |
|                        |                         |                                |                         |                          |                         |                           |                        |                          |                      |
| 133<br>Tangerine       | 014<br>Tomato<br>Red    | 125<br>Wild<br>Cardinal<br>Red | 172<br>Poppy<br>Red     | 001<br>Red               | 012<br>Burgundy         | 076<br>Magenta            | 124<br>Fiesta<br>Pink  | 063<br>Violet            | 074<br>Lavender      |
|                        |                         |                                |                         |                          |                         |                           |                        |                          |                      |
| 168<br>Plum            | 011<br>Dark<br>Blue     | 266<br>Patriot<br>Blue         | 017<br>Sapphire<br>Blue | 005<br>Blue              | 032<br>Azure<br>Blue    | 018<br>Olympic<br>Blue    | 108<br>Peacock<br>Blue | 206<br>Breakfast<br>Blue | 071<br>Teal          |
|                        |                         |                                |                         |                          |                         |                           |                        |                          |                      |
| 142<br>Forest<br>Green | 126<br>Emerald<br>Green | 061<br>Kelly<br>Green          | 252<br>Mint<br>Green    | 257<br>Lime<br>Green     | 024<br>Dark<br>Green    |                           |                        |                          |                      |



Intermediate Films

# Lumina

by FDC

4725 / 4775  
Intermediate  
Film Rolls



| Area of Use  | Common Applications  | Durability | Dimensions   |
|--|--|------------|--|
| <ul style="list-style-type: none"> <li>- Flat Surfaces</li> <li>- Indoor &amp; Outdoor</li> <li>- Simple Curves</li> <li>- Corrugations</li> </ul> | <ul style="list-style-type: none"> <li>- Signage</li> <li>- Crafting</li> <li>- Vehicles</li> <li>- Banners</li> </ul> | - 6 Years  | Width<br>3/8", 1/2", 3/4", 1", 2", 3", 4", 5",<br>6" 8", 10", 12", 15", 20", 24", 30",<br>36", 39", 48", 60"<br>Length<br>5 yd, 10 yd, 50 yd |

|                    |                       |                       |                          |                          |                       |                      |                                  |                      |                     |
|--------------------|-----------------------|-----------------------|--------------------------|--------------------------|-----------------------|----------------------|----------------------------------|----------------------|---------------------|
|                    |                       |                       |                          |                          |                       |                      |                                  |                      |                     |
| 114<br>Transparent | 010<br>Gloss<br>White | 020<br>Matte<br>White | 120<br>Satin<br>Aluminum | 214<br>Light<br>Ash Gray | 012<br>Gloss<br>Black | 222<br>Flat<br>Black | 019<br>Deep<br>Mahogany<br>Brown | 131<br>Satin<br>Gold | 263<br>New<br>Beige |

|                        |                           |               |                  |                         |                      |                        |                        |                         |                |
|------------------------|---------------------------|---------------|------------------|-------------------------|----------------------|------------------------|------------------------|-------------------------|----------------|
|                        |                           |               |                  |                         |                      |                        |                        |                         |                |
| 080<br>Matte<br>Yellow | 135<br>Primrose<br>Yellow | 006<br>Yellow | 025<br>Sunflower | 014<br>Bright<br>Orange | 013<br>Tomato<br>Red | 063<br>Geranium<br>Red | 053<br>Cardinal<br>Red | 068<br>Dark<br>Burgundy | 076<br>Magenta |

|                 |                        |                      |                         |                        |                     |             |                      |                        |
|-----------------|------------------------|----------------------|-------------------------|------------------------|---------------------|-------------|----------------------|------------------------|
|                 |                        |                      |                         |                        |                     |             |                      |                        |
| 075<br>Lavender | 038<br>Royal<br>Purple | 197<br>Light<br>Navy | 037<br>Sapphire<br>Blue | 057<br>Olympic<br>Blue | 262<br>Baby<br>Blue | 071<br>Teal | 056<br>Dark<br>Green | 186<br>Bright<br>Green |

4304 / 4354 Intermediate Film Rolls

|              |               |                         |
|--------------|---------------|-------------------------|
|              |               |                         |
| 002<br>White | 006<br>Yellow | 017<br>Sapphire<br>Blue |



**Intermediate Films**

# Lumina

by FDC

**4301 / 4351  
Intermediate  
Film Rolls**



| Area of Use  | Common Applications  | Durability | Dimensions  |
|--|--|------------|---|
| <ul style="list-style-type: none"> <li>- Flat Surfaces</li> <li>- Indoor &amp; Outdoor</li> <li>- Simple Curves</li> <li>- Corrugations</li> </ul> | <ul style="list-style-type: none"> <li>- Signage</li> <li>- Crafting</li> <li>- Vehicles</li> <li>- Banners</li> </ul> | - 6 Years  | Width<br>3/8", 1/2", 3/4", 1", 2", 3", 4", 5",<br>6", 8", 10", 12", 15", 20", 24", 30",<br>36", 39", 48", 60"<br>Length<br>5 yd, 10 yd, 50 yd |

|              |                         |               |                       |              |              |             |              |                        |              |
|--------------|-------------------------|---------------|-----------------------|--------------|--------------|-------------|--------------|------------------------|--------------|
|              |                         |               |                       |              |              |             |              |                        |              |
| 049<br>White | 202<br>Restful<br>White | 007<br>Silver | 050<br>Medium<br>Gray | 008<br>Brown | 040<br>Black | 004<br>Gold | 068<br>Beige | 080<br>Matte<br>Yellow | 113<br>Coral |

|                  |                             |            |                |                       |             |                     |                      |                        |                          |
|------------------|-----------------------------|------------|----------------|-----------------------|-------------|---------------------|----------------------|------------------------|--------------------------|
|                  |                             |            |                |                       |             |                     |                      |                        |                          |
| 133<br>Tangerine | 125<br>Wild<br>Cardinal Red | 001<br>Red | 076<br>Magenta | 124<br>Fiesta<br>Pink | 168<br>Plum | 011<br>Dark<br>Blue | 032<br>Azure<br>Blue | 108<br>Peacock<br>Blue | 206<br>Breakfast<br>Blue |

|                        |                         |                      |                      |
|------------------------|-------------------------|----------------------|----------------------|
|                        |                         |                      |                      |
| 142<br>Forest<br>Green | 126<br>Emerald<br>Green | 252<br>Mint<br>Green | 257<br>Lime<br>Green |

Ultra Metallic Cast Films

# Lumina

by FDC

**3710**  
**Ultra-Metallic**  
**Cast Film Rolls**



| Area of Use  | Common Applications  | Durability  | Dimensions   |
|--|--|---|--|
| <ul style="list-style-type: none"> <li>- Flat Surfaces</li> <li>- Indoor &amp; Outdoor</li> <li>- Simple Curves</li> <li>- Corrugations</li> </ul> | <ul style="list-style-type: none"> <li>- Signage</li> <li>- Crafting</li> <li>- Vehicles</li> <li>- Banners</li> </ul> | <ul style="list-style-type: none"> <li>- 2 Years</li> </ul> | Width<br>12", 15", 24", 30", 48", 54", 60"<br>Length<br>41 ft, 82 ft |

|                      |                           |                         |                     |                        |                  |                          |                         |                          |                        |
|----------------------|---------------------------|-------------------------|---------------------|------------------------|------------------|--------------------------|-------------------------|--------------------------|------------------------|
|                      |                           |                         |                     |                        |                  |                          |                         |                          |                        |
| 002<br>White         | 195<br>Onyx               | 003<br>Black            | 009<br>Orange       | 001<br>Red             | 057<br>Raspberry | 076<br>Bubblegum<br>Pink | 074<br>Royal<br>Purple  | 071<br>Teal              | 261<br>Diamond<br>Dust |
|                      |                           |                         |                     |                        |                  |                          |                         |                          |                        |
| 113<br>Coral         | 242<br>Medium<br>Burgundy | 125<br>Wild<br>Card Red | 224<br>Rose<br>Gold | 260<br>Desert<br>Taupe | 075<br>Lavender  | 030<br>Dark<br>Blue      | 017<br>Sapphire<br>Blue | 206<br>Breakfast<br>Blue | 193<br>Sea<br>Foam     |
|                      |                           |                         |                     |                        |                  |                          |                         |                          |                        |
| 024<br>Dark<br>Green | 008<br>Brown              |                         |                     |                        |                  |                          |                         |                          |                        |



## BLOCK-OUT MEDIA



# 3M

**3635  
Light Management  
Series**



### Light Enhancement Films



100  
Matte

### Dual Color Films



210  
White



222  
Black



157  
Sultan  
Blue

### Diffuser Films



030  
30%  
Light  
Transmission



070  
70%  
Light  
Transmission

### Day/Night Films



091  
Smoke  
Gray



171  
Dark  
Gray

### Blockout Films



020  
White/  
Black



022  
Black/  
White



110  
Chrome

3M™ 3635 Light Management Films – Dual Color Films. These films are used to create the special effect of a color/image by day (non lighted) and a different color by night (backlit). This is achieved when a background color/image glows through the perforations in the dual color film. From a typical viewing distance for large format graphics, viewers will notice little or no perforation pattern.



Block-out Media



SC 900  
Block-out  
Media



|                                       |                                     |                        |                              |                         |                        |                                     |
|---------------------------------------|-------------------------------------|------------------------|------------------------------|-------------------------|------------------------|-------------------------------------|
|                                       |                                     |                        |                              |                         |                        |                                     |
| 108<br>HITACK<br>SF<br>Cover<br>White | 151<br>PERM SF<br>White<br>Blockout | 190<br>LTR EZ<br>Black | 190<br>HITACK<br>SF<br>Black | 190<br>PERM SF<br>Black | 190<br>LTR SF<br>Black | 152<br>PERM SF<br>Black<br>Blockout |



Avery Dennison® SC 900 Opaque Easy Apply high performance Super Cast vinyl films are premium quality, flexible, opaque solid color, high gloss, thin, vinyl films designed for use in architectural, transportation and general signage markings requiring ease of use during application.

Easy Apply™ technology is a revolutionary way to maximize productivity, making projects quicker and easier. The embossed liner creates air egress channels in the adhesive providing smooth coverage and fewer wrinkles.



## TRANSLUCENT FILMS

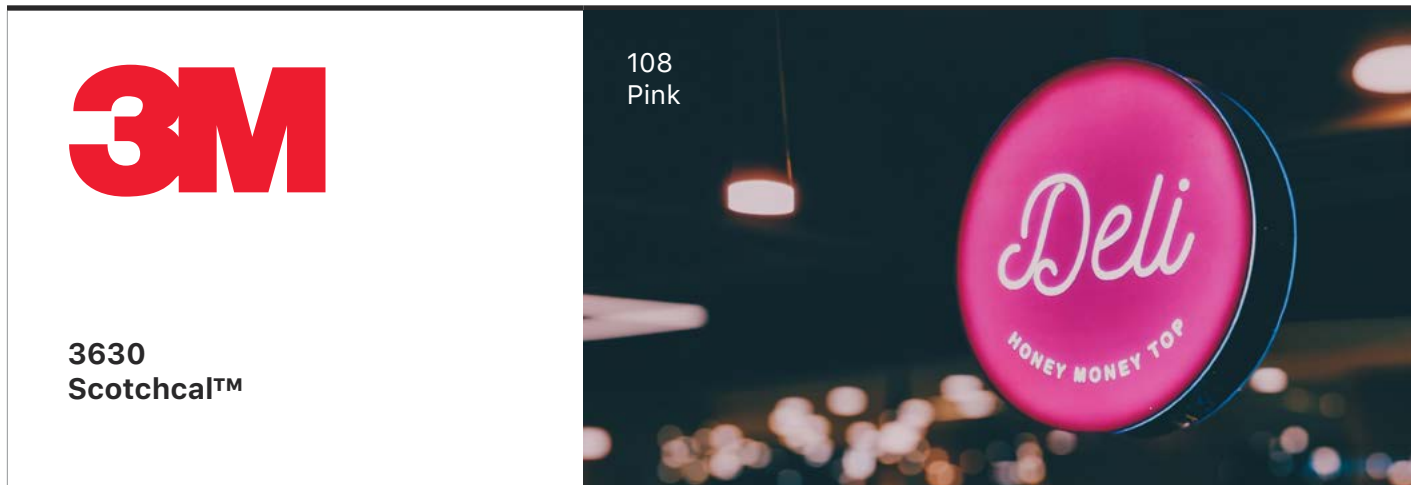

| Area of Use                           | Common Applications     | Durability | Dimensions   |
|---------------------------------------|-------------------------|------------|--|
| - Flat Surfaces<br>- Indoor & Outdoor | - Signage<br>- Crafting | - 3 Years  | Width<br>15", 24", 30", 48", 60"<br>Length<br>10 yd, 50 yd |

|                       |                           |                        |                         |                          |                           |                         |                             |                         |                            |
|-----------------------|---------------------------|------------------------|-------------------------|--------------------------|---------------------------|-------------------------|-----------------------------|-------------------------|----------------------------|
|                       |                           |                        |                         |                          |                           |                         |                             |                         |                            |
| 020<br>White          | 121<br>Silver             | 051<br>Silver<br>Gray  | 071<br>Shadow<br>Gray   | 061<br>Slate<br>Gray     | 069<br>Duranodic          | 022<br>Black            | 059<br>Dark<br>Brown        | 06<br>Rust<br>Brown     | 109<br>Light Rust<br>Brown |
|                       |                           |                        |                         |                          |                           |                         |                             |                         |                            |
| 129<br>Bronze         | 131<br>Gold<br>Metallic   | 141<br>Gold<br>Nugget  | 149<br>Light<br>Beige   | 005<br>Ivory             | 015<br>Yellow             | 125<br>Golden<br>Yellow | 075<br>Marigold             | 025<br>Sunflower        | 074<br>Kumquat<br>Orange   |
|                       |                           |                        |                         |                          |                           |                         |                             |                         |                            |
| 084<br>Tangerine      | 044<br>Light<br>Tomato    | 043<br>Light<br>Tomato | 143<br>Poppy<br>Red     | 083<br>Regal<br>Red      | 033<br>Red                | 073<br>Dark<br>Red      | 053<br>Cardinal<br>Red      | 049<br>Burgundy         | 128<br>Plum<br>Purple      |
|                       |                           |                        |                         |                          |                           |                         |                             |                         |                            |
| 133<br>Raspberry      | 118<br>Intense<br>Magenta | 078<br>Vivid<br>Rose   | 108<br>Pink             | 068<br>Rose<br>Mauve     | 087<br>Royal<br>Blue      | 036<br>Blue             | 137<br>European<br>Blue     | 157<br>Sultan<br>Blue   | 097<br>Bristol<br>Blue     |
|                       |                           |                        |                         |                          |                           |                         |                             |                         |                            |
| 167<br>Bright<br>Blue | 127<br>Intense<br>Blue    | 337<br>Process<br>Blue | 057<br>Olympic<br>Blue  | 147<br>Light<br>European | 317<br>Evening<br>Blue    | 246<br>Teal<br>Green    | 236<br>Turquoise            | 126<br>Dark<br>Emerald  | 077<br>Indigo              |
|                       |                           |                        |                         |                          |                           |                         |                             |                         |                            |
| 227<br>Azure          | 076<br>Holly<br>Green     | 086<br>Blue<br>Lagoon  | 235<br>Autumn<br>Yellow | 026<br>Green             | 093<br>Fire<br>Engine Red | 276<br>Kentucky<br>Blue | 116<br>Bright<br>Jade Green | 098<br>Electric<br>Pink | 287<br>Marine<br>Blue      |

### 3M 3630 Scotchcal™ Translucent Films

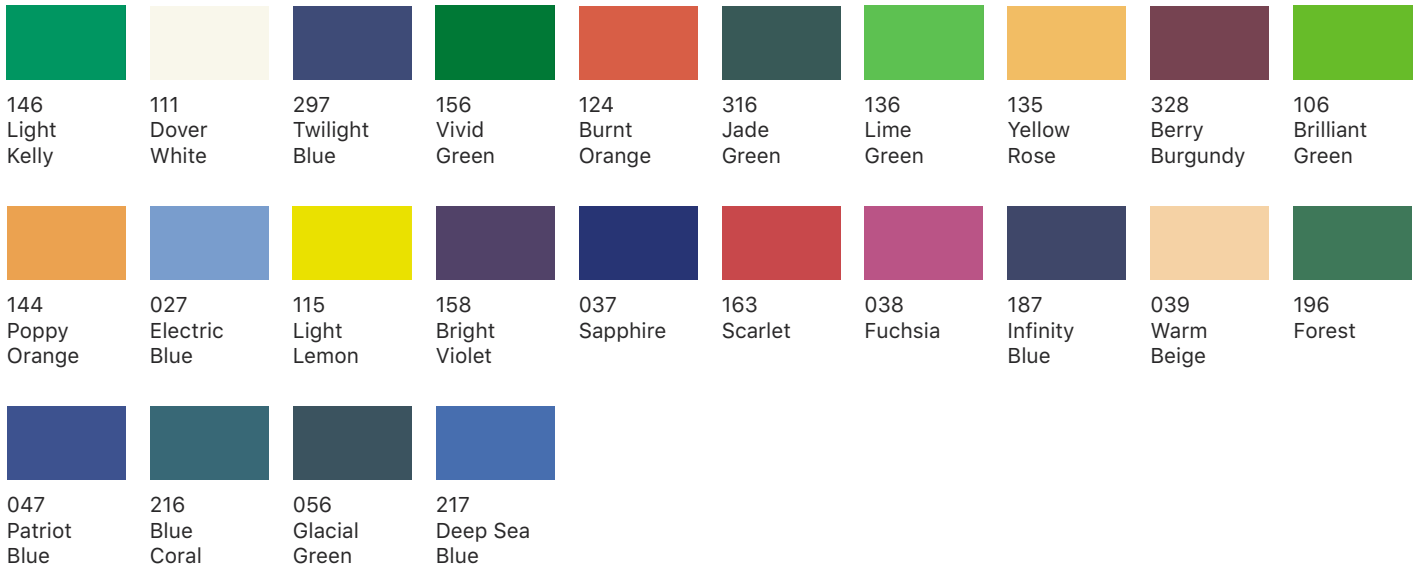

### 3M 1170 ElectroCut™ Translucent Films



**PR800 Translucent Films**



**PR800  
Translucent  
Film Rolls**



| Area of Use  | Common Applications  | Durability | Dimensions   |
|--|--|------------|--|
| <ul style="list-style-type: none"> <li>- Flat Surfaces</li> <li>- Flat with Rivets</li> <li>- Corrugations</li> <li>- Deep Recesses</li> <li>- Indoor &amp; Outdoor</li> </ul> | <ul style="list-style-type: none"> <li>- Architectural Signage</li> <li>- Outdoor Advertising</li> <li>- Directional Signage</li> <li>- Window</li> <li>- Backlit</li> </ul> | - 6 years  | Width<br>12", 15", 30", 48", 60"<br>Length<br>5 yd, 10 yd, 25 yd |

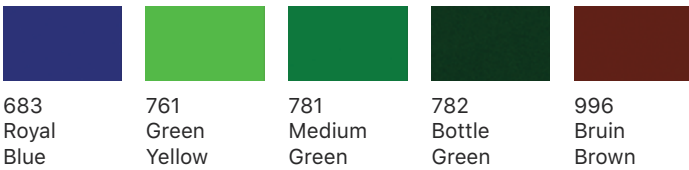

Translucent Ultimate Cast Films



**UC900  
Translucent  
Film Rolls**



| Area of Use   | Common Applications  | Durability  | Dimensions   |
|---|--|---|--|
| <ul style="list-style-type: none"> <li>- Flat Surfaces</li> <li>- Indoor &amp; Outdoor</li> </ul> | <ul style="list-style-type: none"> <li>- Architectural Signage</li> <li>- Outdoor Advertising</li> <li>- Directional Signage</li> <li>- Window</li> <li>- Backlit</li> </ul> | <ul style="list-style-type: none"> <li>- 6 years</li> </ul> | Width<br>12", 15", 30", 48", 60"<br>Length<br>5 yd, 10 yd, 25 yd |

|                           |                     |                      |                        |                        |                     |            |                    |                 |                |
|---------------------------|---------------------|----------------------|------------------------|------------------------|---------------------|------------|--------------------|-----------------|----------------|
|                           |                     |                      |                        |                        |                     |            |                    |                 |                |
| 361<br>Goldfish<br>Orange | 408<br>Coral<br>Red | 421<br>Red<br>Orange | 424<br>Light<br>Tomato | 428<br>Imperial<br>Red | 434<br>Vivid<br>Red | 440<br>Red | 468<br>Wine<br>Red | 470<br>Burgundy | 516<br>Fuchsia |

|             |                         |                      |                           |                       |                      |                       |                    |                       |                               |
|-------------|-------------------------|----------------------|---------------------------|-----------------------|----------------------|-----------------------|--------------------|-----------------------|-------------------------------|
|             |                         |                      |                           |                       |                      |                       |                    |                       |                               |
| 546<br>Plum | 560<br>Bright<br>Purple | 602<br>Pearl<br>Blue | 603<br>Cornflower<br>Blue | 626<br>French<br>Blue | 661<br>Capri<br>Blue | 668<br>Island<br>Blue | 684<br>Deep<br>Sea | 686<br>Cobalt<br>Blue | 685<br>Ultra Marine<br>Marine |

|                         |                     |                        |                       |                          |                          |                        |                      |                        |                       |
|-------------------------|---------------------|------------------------|-----------------------|--------------------------|--------------------------|------------------------|----------------------|------------------------|-----------------------|
|                         |                     |                        |                       |                          |                          |                        |                      |                        |                       |
| 691<br>Twilight<br>Blue | 692<br>Real<br>Blue | 693<br>Neptune<br>Blue | 669<br>Bright<br>Teal | 722<br>Amazonite<br>Teal | 726<br>Parakeet<br>Green | 734<br>Citrus<br>Green | 762<br>Palm<br>Green | 783<br>Safari<br>Green | 794<br>Holly<br>Green |

|                    |                       |                        |
|--------------------|-----------------------|------------------------|
|                    |                       |                        |
| 811<br>Fog<br>Gray | 837<br>Cement<br>Gray | 869<br>Light<br>Silver |





Translucent Cast Films

**Lumina**  
by FDC

**2520 / 2550**  
**Translucent Film Rolls**



| Area of Use  | Common Applications   | Durability | Dimensions  |
|--|---|------------|---|
| <ul style="list-style-type: none"> <li>- Flat Surfaces</li> <li>- Simple Curves</li> <li>- Indoor &amp; Outdoor</li> </ul> | <ul style="list-style-type: none"> <li>- Signage</li> <li>- Crafting</li> </ul> | - 7 Years  | Width<br>1/4" 3/8", 1/2", 3/4", 1", 2", 3", 4",<br>5", 6" 8", 10", 12", 15", 18", 24",<br>30", 36", 39", 48",<br>Length<br>5 yd, 10 yd, 50 yd |

|                       |                        |                      |                       |                           |                  |                        |                       |                       |                       |
|-----------------------|------------------------|----------------------|-----------------------|---------------------------|------------------|------------------------|-----------------------|-----------------------|-----------------------|
|                       |                        |                      |                       |                           |                  |                        |                       |                       |                       |
| 020<br>White          | 197<br>Gray            | 054<br>Charcoal      | 040<br>Black          | 059<br>Dark<br>Brown      | 069<br>Duranodic | 021<br>Ivory           | 015<br>Yellow         | 006<br>Mango          | 044<br>Orange         |
|                       |                        |                      |                       |                           |                  |                        |                       |                       |                       |
| 073<br>Dark<br>Red    | 033<br>Red             | 014<br>Tomato<br>Red | 172<br>Poppy<br>Red   | 049<br>Burgundy           | 133<br>Magenta   | 198<br>Vivid<br>Rose   | 155<br>Plum<br>Purple | 077<br>Dark<br>Blue   | 087<br>Royal<br>Blue  |
|                       |                        |                      |                       |                           |                  |                        |                       |                       |                       |
| 017<br>Cobalt<br>Blue | 173<br>Process<br>Blue | 018<br>Olympic       | 067<br>Bright<br>Blue | 108<br>Light Baby<br>Blue | 162<br>Teal      | 130<br>Pacific<br>Blue | 026<br>Green          | 126<br>Vivid<br>Green | 024<br>Holly<br>Green |



## REFLECTIVE VINYL



**3M™  
Scotchcal™  
ElectroCut™**

*Please see our website for area of use, common applications, durability and dimensions for each product line.*

### 3200 Engineer Grade Reflective Sheeting



### 3930 High Intensity Prismatic Reflective Sheeting

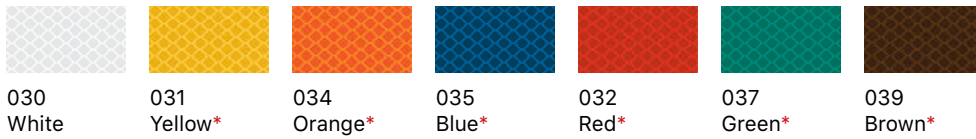

\* Available by special Order

### 5100R Scotchlite Reflective Graphic Film



### 983 Diamond Grade Conspicuity Markings

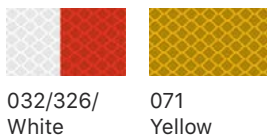

### 580, 680 and 680CR Scotchlite Reflective Graphic Film

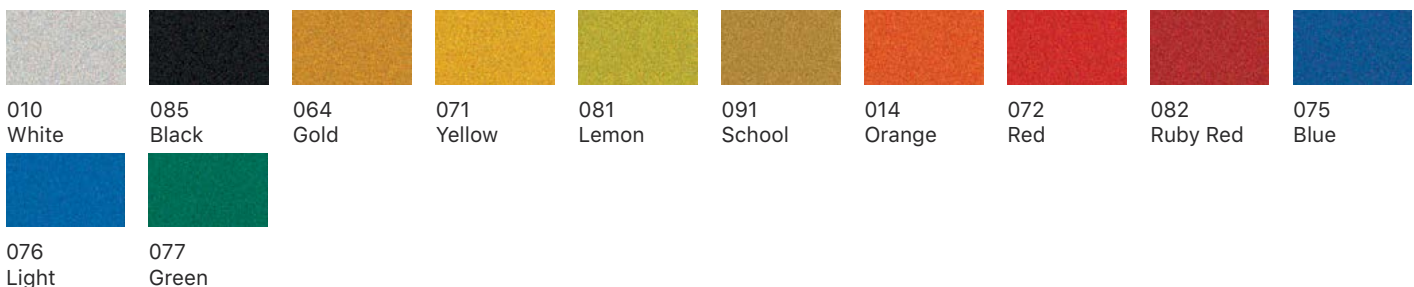

Reflective Film

# Lumina

by FDC

2407 / 2457  
Intermediate  
Film Rolls



| Area of Use  | Common Applications   | Durability | Dimensions   |
|--|---|------------|--|
| <ul style="list-style-type: none"> <li>- Flat Surfaces</li> <li>- Simple Curves</li> <li>- Indoor &amp; Outdoor</li> </ul> | <ul style="list-style-type: none"> <li>- Signage</li> <li>- Crafting</li> </ul> | - 5 Years  | Width<br>15", 18", 24", 30", 36", 39", 48",<br>Length<br>5 yd, 10 yd, 50 yd, |

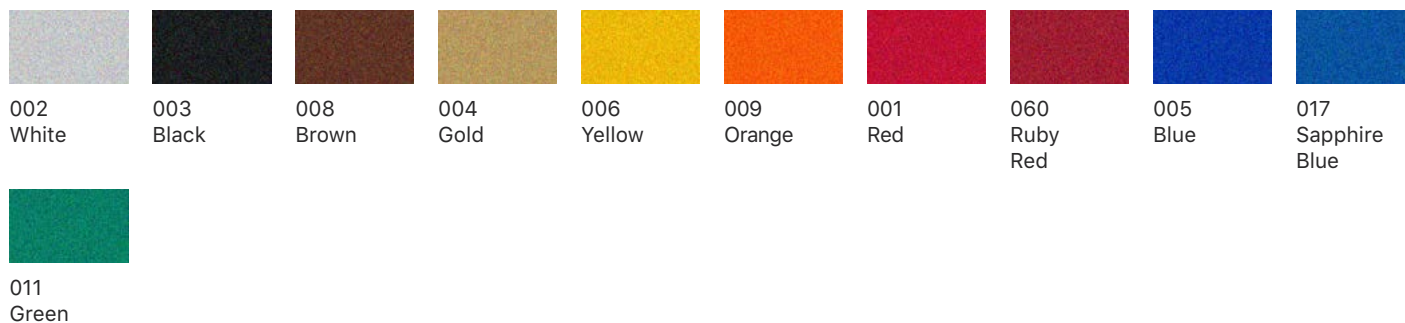

## 2409 / 2459 Intermediate Film Rolls

| Area of Use   | Common Applications   | Durability | Dimensions   |
|---|---|------------|--|
| <ul style="list-style-type: none"> <li>- Flat Surfaces</li> <li>- Simple Curves</li> <li>- Banners</li> <li>- Indoor &amp; Outdoor</li> </ul> | <ul style="list-style-type: none"> <li>- Signage</li> <li>- Crafting</li> </ul> | - 5 Years  | Width<br>1/2", 3/4", 1", 2", 3", 4", 5", 6" 8",<br>10", 12", 15", 18", 24", 30", 36",<br>39", 48",<br>Length<br>5 yd, 10 yd, 50 yd |

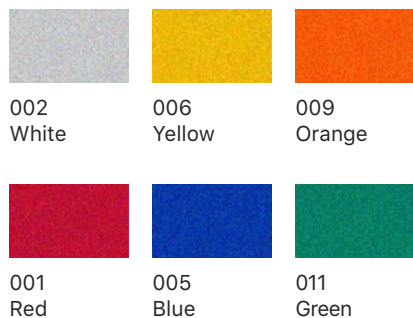

## SPECIALTY FILMS



# Lumina

by FDC

### Specialty Film Rolls

Please see our website for area of use, common applications, durability and dimensions for each product line.

#### 1203 / 1253

Promotional Static Cling Film

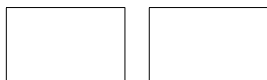

000 Clear      002 White

#### 3501 / 3551

Promotional Fluorescent Vinyl Film



056 Pink      069 Green      009 Orange

#### 4306 / 4356

Promotional Enamel Receptive Vinyl Film

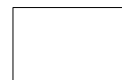

000 Clear

#### 2800 / 2850

Promotional Metalized Mirror Finish Polyester Film



004 Gold      007 Silver

#### 3804 / 3854

Intermediate Frosted Crystal Vinyl Film



005 Frosted Blue

#### 4305 / 4355

Promotional Dry Erase Vinyl Film



000 Clear      002 White

#### 2801 / 2851

Metalized Brushed Finish Polyester Film



004 Gold      007 Silver

#### 3300 / 3350

Imitation Leaf Vinyl Film

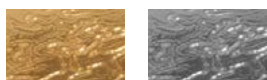

004 Gold      007 Silver

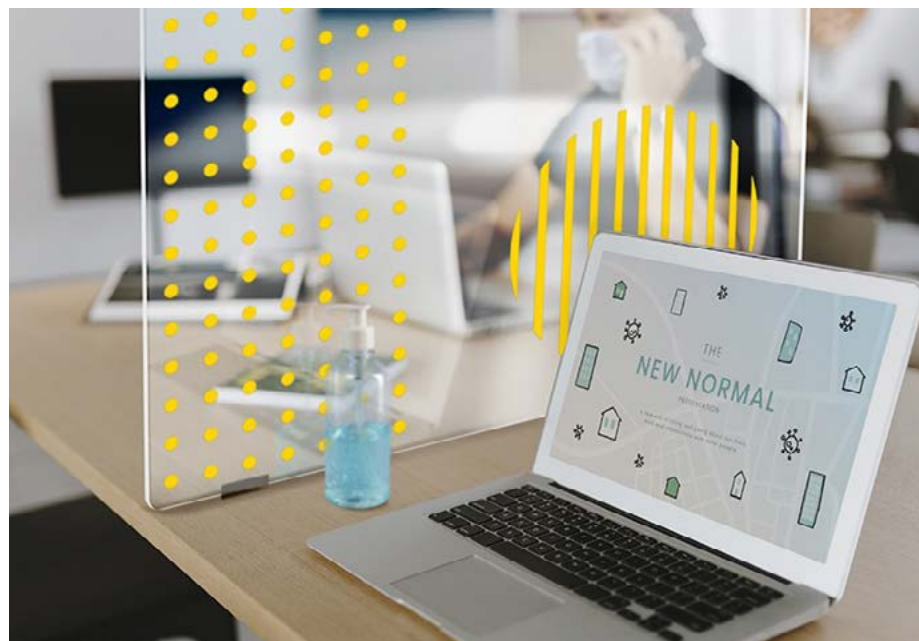

Specialty Films



**VinylEfx  
Special Vinyl  
Series**

*Please see our website for area of use, common applications, durability and dimensions for each product line.*



**VinylEfx 2824**

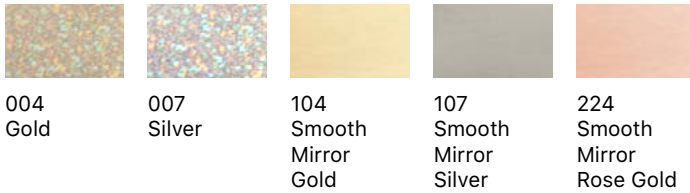

**VinylEfx 2826**



**VinylEfx 2827**



**VinylEfx 4310**

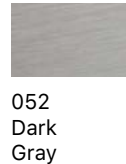

**VinylEfx 4826**

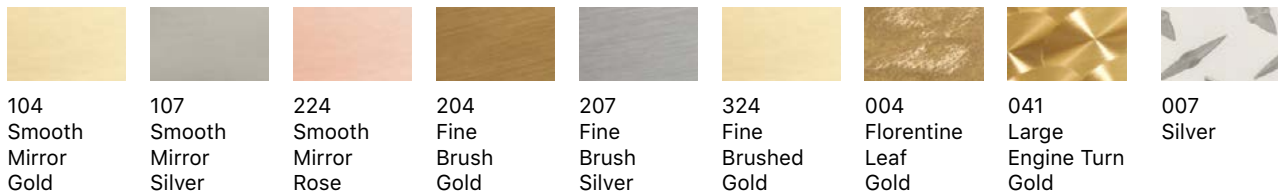

**VinylEfx 4827**



**SF100 Polyester Series**

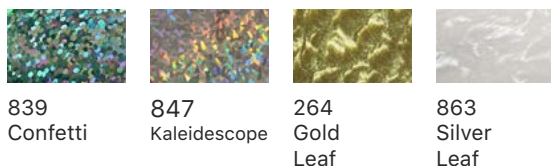

*Please see our website for area of use, common applications, durability and dimensions for each product line.*



## FLUORESCENT CAST VINYL



**SF100**  
**Fluorescent Cast**  
**Vinyl Films**

| Area of Use | Common Applications | Durability | Dimensions |
|-------------|---------------------|------------|------------|
|-------------|---------------------|------------|------------|

- Flat Surfaces
- Simple Curves
- Indoor & Outdoor

- Architectural Signage
- Outdoor Advertising
- Directional Signage
- Window
- Vehicle Wraps

- 3 to 6 months

Width  
 15", 24", 30", 48"  
 Length  
 10 yd, 50 yd

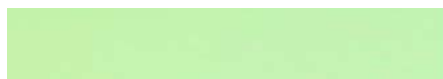
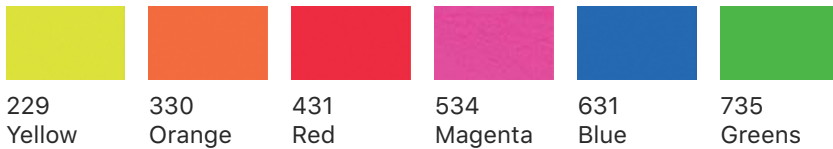

120  
 Glow in  
 The Dark

Avery Dennison Glow-in-the-dark Film is a specialty photoluminescent non-coated rigid polyester film that can be.



**TACK TRANSFER TAPES**



**rtape**  
Tack Transfer  
Tapes



| Key Features    |           |             |               | Available Sizes |               | Item #                     |
|-----------------|-----------|-------------|---------------|-----------------|---------------|----------------------------|
| Thickness (mil) | Tack      | Opacity     | Backing       | Width           | Length        |                            |
| 5               | Low       | White       | Paper         |                 |               | <b>4000 ApliTape™</b>      |
| 5               | Medium    | White       | Paper         | 1-1/4"          |               | <b>4050 ApliTape™</b>      |
| 5               | High Tack | White       | Paper         | 2-1/4"          |               | <b>4075 ApliTape™</b>      |
| 4.2             | Medium    | Translucent | Paper         | 3-1/4"          |               | <b>4050 RLA® Conform®</b>  |
| 4.2             | High      | Translucent | Paper         | 4-1/4"          |               | <b>4075 RLA® Conform®</b>  |
| 4.5             | Very High | White       | Paper         | 5-1/4"          |               | <b>4076 RLA® Conform®</b>  |
| 4.1             | Medium    | White       | Paper         | 6-1/2"          |               | <b>4078 RLA® Conform®</b>  |
| 5.5             | Medium    | White       | Paper         | 8-1/2"          |               | <b>4750 RLA® Conform®</b>  |
| 3               | High      | Translucent | Paper         | 10-1/2"         |               | <b>4775 RLA® Conform®</b>  |
| 4.1             | High      | Clear       | Paper         | 12"             | 50 yd rolls & | <b>4761 RLA® Conform®</b>  |
| 3.7             | Low       | Transparent | Polypropylene | 14"             | 100 yd rolls  | <b>AT60n Clear Choice®</b> |
| 4.2             | High      | Transparent | Polypropylene | 15"             |               | <b>AT75 Clear Choice®</b>  |
| 3.7             | High      | Transparent | Polypropylene | 16"             |               | <b>AT65 Clear Choice®</b>  |
|                 |           |             |               | 18"             |               |                            |
|                 |           |             |               | 20"             |               |                            |
|                 |           |             |               | 24"             |               |                            |
|                 |           |             |               | 30"             |               |                            |
|                 |           |             |               | 36"             |               |                            |
|                 |           |             |               | 48"             |               |                            |
|                 |           |             |               | 54"             |               |                            |
|                 |           |             |               | 60"             |               |                            |



| Key Features    |        |                  |         | Available Sizes |                  |              |              |              |              | Item #      |
|-----------------|--------|------------------|---------|-----------------|------------------|--------------|--------------|--------------|--------------|-------------|
| Thickness (mil) | Tack   | Opacity          | Backing |                 |                  |              |              |              |              |             |
|                 |        |                  |         | 6 1/2" x 100 yd | 12 1/2" x 100 yd | 14" x 100 yd | 24" x 100 yd | 30" x 100 yd | 48" x 100 yd |             |
| 2.5             | Medium | Semi-Transparent | Paper   | ✓               | ✓                | ✓            | ✓            | ✓            | ✓            | <b>ATTM</b> |
| 3               | High   | Semi-Transparent | Paper   | ✓               | ✓                | ✓            | ✓            | ✓            | ✓            | <b>ATTH</b> |

Tack Transfer Tapes

**TransferRite®**

**TransferRite  
Tack Transfer  
Tapes**



| Key Features    |           |             |               | Available Sizes |             |             |             |              |              |              |              |              |              | Item #       |         |
|-----------------|-----------|-------------|---------------|-----------------|-------------|-------------|-------------|--------------|--------------|--------------|--------------|--------------|--------------|--------------|---------|
| Thickness (mil) | Tack      | Opacity     | Backing       | 2" x 100 yd     | 4" x 100 yd | 6" x 100 yd | 8" x 100 yd | 12" x 100 yd | 16" x 100 yd | 24" x 100 yd | 30" x 100 yd | 48" x 100 yd | 54" x 100 yd | 60" x 100 yd |         |
| 3.9             | Low       | Ultra Clear | Polypropylene |                 |             |             |             | ✓            |              | ✓            | ✓            | ✓            |              |              | TR1301  |
| 3.9             | Medium    | Ultra Clear | Polypropylene | ✓               | ✓           | ✓           | ✓           | ✓            | ✓            | ✓            | ✓            | ✓            |              |              | TR1310G |
| 3.9             | Medium    | Ultra Clear | Polypropylene | ✓               | ✓           | ✓           | ✓           | ✓            |              | ✓            | ✓            | ✓            |              |              | TR1310U |
| 3.9             | High      | Clear       | Polypropylene |                 |             |             |             | ✓            | ✓            | ✓            | ✓            |              |              |              | TR1320  |
| 4.2             | Medium    | Clear       | Polypropylene | ✓               | ✓           | ✓           | ✓           | ✓            | ✓            | ✓            | ✓            | ✓            |              |              | TR1510  |
| 4.3             | High      | Ultra Clear | Polypropylene |                 |             |             |             |              |              | ✓            | ✓            | ✓            | ✓            | ✓            | TR510U  |
| 4.3             | Medium    | Ultra Clear | Paper         |                 |             |             |             |              |              | ✓            | ✓            | ✓            |              |              | TR560U  |
| 4.3             | Medium    | Clear       | Paper         | ✓               | ✓           | ✓           | ✓           | ✓            |              | ✓            | ✓            | ✓            |              |              | TR582U  |
| 4.3             | High      | Ultra Clear | Paper         | ✓               | ✓           | ✓           | ✓           | ✓            |              | ✓            | ✓            | ✓            |              |              | TR592U  |
| 4               | Medium    | Clear       | Paper         | ✓               | ✓           | ✓           | ✓           | ✓            |              |              |              |              |              |              | TR6582  |
| 5.6             | Very High | Clear       | Paper         |                 |             |             |             |              |              | ✓            | ✓            | ✓            |              |              | TR6798  |
| 5.5             | Medium    | Clear       | Paper         |                 |             |             |             | ✓            |              | ✓            | ✓            | ✓            |              |              | TR6882  |
| 5.4             | Low       | Ultra Clear | Paper         | ✓               | ✓           | ✓           | ✓           | ✓            | ✓            | ✓            | ✓            | ✓            |              |              | TR760U  |
| 5.4             | Medium    | Ultra Clear | Paper         |                 |             |             |             |              |              | ✓            | ✓            | ✓            |              |              | TR782U  |
| 5.4             | High      | Ultra Clear | Paper         | ✓               | ✓           | ✓           | ✓           | ✓            | ✓            | ✓            | ✓            | ✓            |              |              | TR792U  |
| 5.4             | Very High | Clear       | Paper         |                 |             |             |             |              |              | ✓            |              | ✓            |              |              | TR794U  |
| 7               | High      | Clear       | Paper         | ✓               | ✓           | ✓           | ✓           | ✓            | ✓            | ✓            | ✓            | ✓            |              |              | TR992U  |





## PAINT MASKS



### SF100 Paint Mask Series



- ▶ Dimensionally stable liner for easy converting
- ▶ Excellent UV, temperature, humidity, and salt-spray resistance
- ▶ Short Term Promotional Applications
- ▶ Easy cutting and weeding for crisp paint lines
- ▶ Removable from most OEM paints
- ▶ Clean removability when used with most paint cycles

| Key Features    |        |         |                   | Available Sizes |             |             |             |             |             |             |             |             |             |              | Item #         |
|-----------------|--------|---------|-------------------|-----------------|-------------|-------------|-------------|-------------|-------------|-------------|-------------|-------------|-------------|--------------|----------------|
| Thickness (mil) | Color  | Punched | Durability (year) | 15" x 10 yd     | 24" x 10 yd | 30" x 10 yd | 48" x 10 yd | 60" x 10 yd | 15" x 50 yd | 24" x 50 yd | 30" x 50 yd | 48" x 50 yd | 60" x 50 yd | 48" x 100 yd |                |
| 3.4             | White  | Yes     | 1                 | ✓               |             | ✓           |             | ✓           | ✓           |             | ✓           |             |             |              | APAINTMASK-128 |
| 3.4             | White  | No      | 1                 |                 | ✓           |             | ✓           |             |             | ✓           | ✓           | ✓           | ✓           | ✓            | APAINTMASK-128 |
| 3.4             | Yellow | No      | 1                 |                 |             |             |             |             |             |             |             | ✓           |             |              | APAINTMASK-231 |
| 1               | Yellow | No      | 3                 |                 |             |             |             |             |             |             |             | ✓           |             |              | APAINTMASK-235 |
| 1               | Yellow | Yes     | 3                 |                 |             |             |             |             | ✓           |             |             | ✓           |             |              | APAINTMASK-235 |

# Lumina

by FDC

## 2901 Promotional Paint Mask

| Key Features    |        |         |                   | Available Sizes   |         | Item # |
|-----------------|--------|---------|-------------------|---|---------|--------|
| Thickness (mil) | Color  | Punched | Durability (year) |   |         |        |
| 3.4             | White  | No      | 1                 | 1/4", 1/2", 1", 2", 3", 4",<br>5", 6", 8", 10", 12",<br>15", 20", 24", 30",<br>36", 39", 48", 60" | x 10 yd | 2901   |
| 3.4             | Yellow | No      | 1                 |   | x 50 yd | 2901   |





MOCCASIN  
Apparel

NEW YORK



LONG ISLAND



# Heat Transfer Vinyl

## **PREMIUM & SPECIALTY HTV FILM**

|                            |    |
|----------------------------|----|
| 9000 Opaque Series         | 60 |
| 9001 Fluorescent Series    | 61 |
| 9002 Jersey Opaque Series  | 61 |
| 9003 Premium Opaque Series | 61 |
| 9010 Quickpress Series     | 62 |

## **REFLECTIVE & GLITTER HTV FILMS**

|                     |    |
|---------------------|----|
| 9105 Glitter Series | 63 |
|---------------------|----|

## **STRETCH, METAL FLAKE, & FLOCK HTV FILMS**

|                            |    |
|----------------------------|----|
| 9004 Stretch Opaque Series | 64 |
| 9106 Metal Flake Series    | 64 |
| 9200 Textured Series       | 64 |

## **HOT METALLIC & PATTERNED HTV FILMS**

|                          |    |
|--------------------------|----|
| 9107 Hot Metallic Series | 65 |
| 9201 Animal Print Series | 65 |
| 9202 Camouflage Series   | 65 |
| 9204 Textured Series     | 65 |

## **PRINT HTV FILMS**

|                         |    |
|-------------------------|----|
| 9300 Gloss White Series | 66 |
| 9302 Matte Clear        | 66 |
| 9304 Matte White        | 66 |
| 9305 Matte White        | 66 |
| 9308 Matte White        | 66 |

PREMIUM & SPECIALTY HTV FILMS

# Lumina

by FDC

**9000**  
is an opaque-colored heat transfer film designed for application to textiles.



001 Red    002 White    003 Black    004 Gold    005 Blue    006 Yellow    007 Silver    008 Brown    011 Dark Blue    012 Burgundy



018 Olympic Blue    023 Deep Red    025 Sunflower    028 Dove Gray    036 Lite Green    047 Tan    048 Camel    056 Hot Pink    060 Bright Cardinal Red    074 Royal Purple



076 Magenta    106 Medium Green    108 Peacock    113 Salmon Pink    130 Teal Blue    133 Tangerine    137 Deep Purple    139 Pale Blue    159 Wineberry    170 Dark Forest Green



174 Chocolate Brown    182 Sunbeam Yellow    190 Cool Water    247 Vibrant Green    253 Lilac    257 Lime Green    260 Desert Taupe    268 Fireworks    280 Light Pink

| Film Technology | Thickness (mil) | CPSIA Compliant | Cotton | Polyester | Layerable | 15" x 5 yd | 15" x 10 yd | 15" x 25 yd | 15" x 50 yd | 20" x 5 yd | 20" x 10 yd | 20" x 25 yd | 20" x 50 yd | Press       | Lumina Series |
|-----------------|-----------------|-----------------|--------|-----------|-----------|------------|-------------|-------------|-------------|------------|-------------|-------------|-------------|-------------|---------------|
| Polyurethane    | 3.5             | Yes             | ●      | ●         | ●         | ✓          | ✓           | ✓           | ✓           | ✓          | ✓           | ✓           | ✓           | Hot or Cold | 9000 Opaque   |



PREMIUM & SPECIALTY HTV FILMS

# Lumina

by FDC

Fluorescent and Opaque colors are ideal for all types of fabric including team gear



### 9001 Fluorescent

Series is an opaque, fluorescent-colored heat transfer film designed for application to textiles.



005 Blue    006 Yellow    009 Orange    057 Raspberry    069 Green    076 Magenta

### 9002 Jersey Opaque

Series is an economy-grade, opaque-colored heat transfer film designed for application to textiles.



002 White    003 Black    004 Gold    005 Blue    007 Silver    012 Burgundy    025 Sunflower    028 Dove Gray    060 Bright Cardinal Red    106 Medium Green    133 Tangerine

### 9003 Premium Opaque

Series is a premium, opaque-colored heat transfer film designed for application to textiles.



001 Red    002 White    003 Black    005 Blue    007 Silver    074 Royal Purple

| Film Technology | Thickness (mil) | CPSIA Compliant | Cotton | Polyester | Leather | Nylon | Layerable | 15" x 5 yd | 15" x 10 yd | 15" x 20yd | 15" x 25 yd | 15" x 50 yd | 15" x 80 yd | 20" x 5 yd | 20" x 10 yd | 20" x 20 yd | 20" x 25yd | 20" x 25 yd | 20" x 50 yd | 20" x 80 yd | Press       | Lumina Series       |
|-----------------|-----------------|-----------------|--------|-----------|---------|-------|-----------|------------|-------------|------------|-------------|-------------|-------------|------------|-------------|-------------|------------|-------------|-------------|-------------|-------------|---------------------|
| Polyurethane    | 3.9             | Yes             | ●      | ●         |         |       | ●         | ✓          | ✓           |            | ✓           | ✓           |             | ✓          | ✓           |             | ✓          | ✓           | ✓           |             |             | 9001 Fluorescent    |
| PVC             | 6.5             | No              | ●      | ●         |         |       | ●         |            |             | ✓          |             |             | ✓           |            |             | ✓           |            |             |             | ✓           | Hot or Cold | 9002 Jersey Opaque  |
| Polyurethane    | 3.5             | Yes             | ●      | ●         | ●       | ●     | ●         | ✓          | ✓           |            | ✓           | ✓           |             |            |             |             |            |             |             |             |             | 9003 Premium Opaque |



PREMIUM & SPECIAL HTV FILMS

# Lumina

by FDC

## 9010 Quickpress Heat Transfer Film

Unlock your potential quicker than ever with a 5-second press time at only 260° F.



**280**  
Fluorescent Pink



001 Red    002 White    003 Black    004 Gold    005 Blue    006 Yellow    007 Silver    009 Fluorescent Orange    011 Dark Blue    018 Olympic Blue



028 Dove Gray    060 Bright Cardinal Red    067 Fluorescent Yellow    076 Magenta    106 Medium Green    133 Tangerine    182 Sunbeam Yellow    247 Vibrant Green    280 Fluorescent Pink

| Film Technology | Thickness (mil) | CPSIA Compliant | Cotton | Polyester | Spandex | Leather | 12" x 5 yd | 12" x 10 yd | 12" x 50 yd | 15" x 5 yd | 15" x 10 yd | 15" x 50 yd | Press | Lumina Series   |
|-----------------|-----------------|-----------------|--------|-----------|---------|---------|------------|-------------|-------------|------------|-------------|-------------|-------|-----------------|
| Polyurethane    | 3.5             | N/A             | ●      | ●         | ●       | ●       | ✓          | ✓           | ✓           | ✓          | ✓           | ✓           | Hot   | 9010 Quickpress |



REFLECTIVE & GLITTER HTV FILMS

# Lumina

by FDC

**9105**

**Glitter Heat Transfer Film**

This series has an attention-grabbing glitter appearance that adds sparkle to graphics.

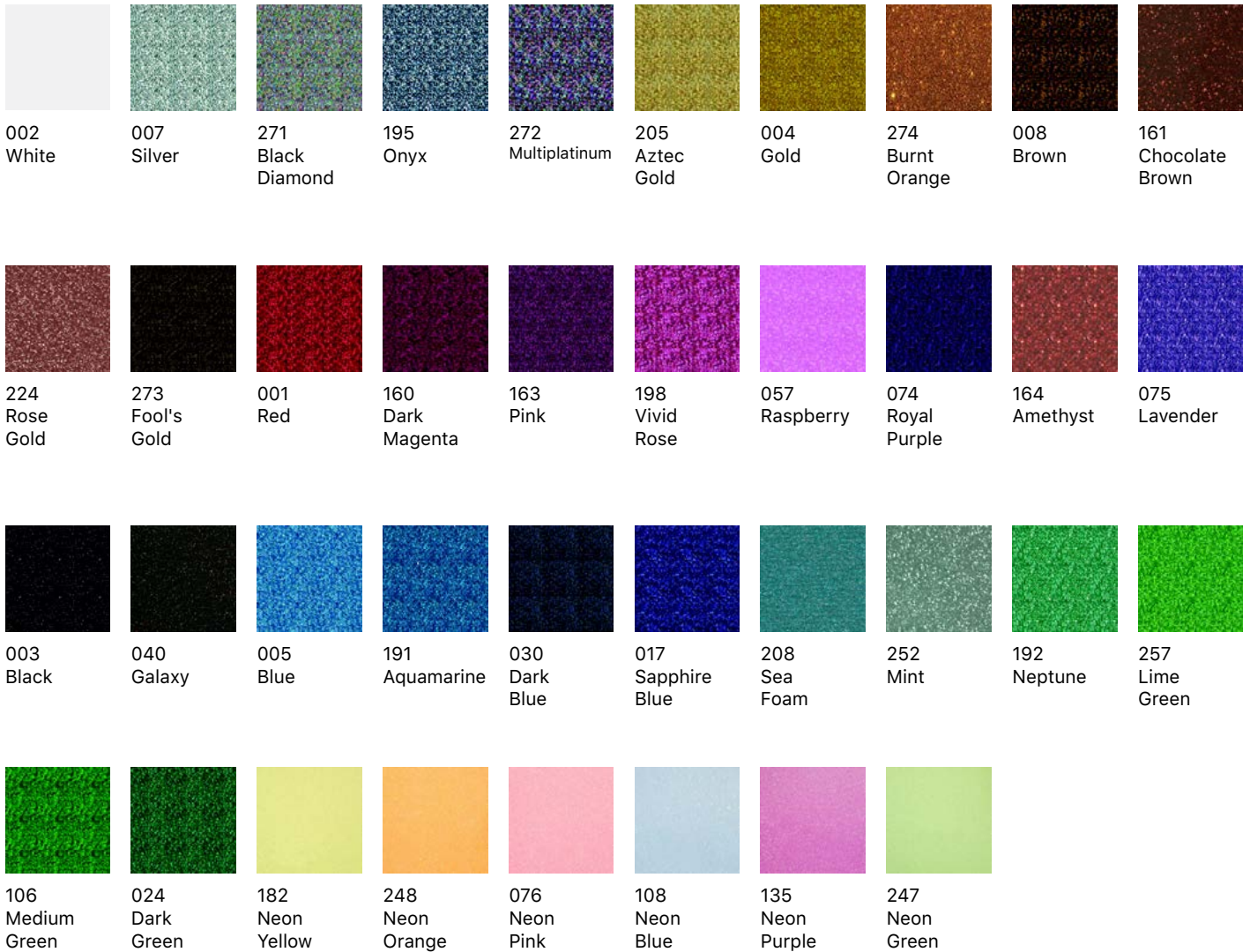

| Film Technology | Thickness (mil) | CPSIA Compliant | Cotton | Polyester | Spandex | Leather | Nylon | Layerable | 15" x 5 yd | 15" x 10 yd | 15" x 25 yd | 15" x 50 yd | 20" x 5 yd | 20" x 10 yd | 20" x 25 yd | 20" x 50 yd | Press | Lumina Series |
|-----------------|-----------------|-----------------|--------|-----------|---------|---------|-------|-----------|------------|-------------|-------------|-------------|------------|-------------|-------------|-------------|-------|---------------|
| PVC             | 12.8            | Yes             | ●      | ●         | ●       | ●       | ●     | ●         | ✓          | ✓           | ✓           | ✓           | ✓          | ✓           | ✓           | ✓           | Hot   | 9105 Glitter  |



**STRETCH, METAL FLAKE, & FLOCK HTV FILMS**

# Lumina

by FDC

## 9004 Stretch Opaque Heat Transfer Film

Series is a very stretchable, opaque colored. Designed for application to performance textiles.



|              |                    |                  |              |                       |                  |            |                     |                   |             |
|--------------|--------------------|------------------|--------------|-----------------------|------------------|------------|---------------------|-------------------|-------------|
|              |                    |                  |              |                       |                  |            |                     |                   |             |
| 002<br>White | 006<br>Yellow      | 133<br>Tangerine | 213<br>Coral | 058<br>Ballerina Pink | 224<br>Rose Gold | 001<br>Red | 106<br>Medium Green | 252<br>Sweet Mint | 005<br>Blue |
|              |                    |                  |              |                       |                  |            |                     |                   |             |
| 011<br>Navy  | 124<br>Purpleberry | 003<br>Black     | 004<br>Gold  | 007<br>Silver         |                  |            |                     |                   |             |

## 9106 Metal Flake Heat Transfer Film

Features a special effect pattern that adds dimension to design.

|               |             |                   |              |                   |                     |             |               |                   |                       |
|---------------|-------------|-------------------|--------------|-------------------|---------------------|-------------|---------------|-------------------|-----------------------|
|               |             |                   |              |                   |                     |             |               |                   |                       |
| 007<br>Silver | 004<br>Gold | 001<br>Cherry Red | 003<br>Black | 005<br>Royal Blue | 106<br>Medium Green | 163<br>Pink | 009<br>Orange | 191<br>Aquamarine | 257<br>Cracked Silver |

## 9200 Textured Heat Transfer Film

This product features a suede-like surface with a raised appearance giving the impression of an embroidered design.

|                  |                       |                  |                  |                 |                   |                            |                     |                     |             |
|------------------|-----------------------|------------------|------------------|-----------------|-------------------|----------------------------|---------------------|---------------------|-------------|
|                  |                       |                  |                  |                 |                   |                            |                     |                     |             |
| 002<br>White     | 182<br>Sunbeam Yellow | 025<br>Sunflower | 133<br>Tangerine | 056<br>Hot Pink | 014<br>Tomato Red | 060<br>Bright Cardinal Red | 106<br>Medium Green | 108<br>Peacock Blue | 005<br>Blue |
|                  |                       |                  |                  |                 |                   |                            |                     |                     |             |
| 011<br>Dark Blue | 168<br>Plum           | 003<br>Black     |                  |                 |                   |                            |                     |                     |             |

| Film Technology | Thickness (mil) | CPS/A Compliant | Cotton | Polyester | Leather | Nylon | Layerable | 15" x 5 yd | 15" x 10 yd | 15" x 25 yd | 15" x 50 yd | 20" x 5 yd | 20" x 10 yd | 20" x 25 yd | 20" x 50 yd | Press       | Lumina Series       |
|-----------------|-----------------|-----------------|--------|-----------|---------|-------|-----------|------------|-------------|-------------|-------------|------------|-------------|-------------|-------------|-------------|---------------------|
| Polyurethane    | 3.5             | Yes             | ●      | ●         | ●       | ●     | ●         | ✓          | ✓           | ✓           | ✓           |            |             |             |             | Hot or Cold | 9004 Stretch Opaque |
| PVC             | 4.3             | Yes             | ●      | ●         |         |       |           | ✓          | ✓           | ✓           | ✓           | ✓          | ✓           | ✓           | ✓           | Hot or Cold | 9106 Metal Flake    |
| Nylon           | 14              | No              | ●      | ●         |         |       | ●         | ✓          | ✓           | ✓           | ✓           |            |             |             |             | Hot or Cold | 9200 Flock          |





HOT METALLIC & PATTERNED HTV FILMS

# Lumina

by FDC

## 9107 Hot Metallic Heat Transfer Film

This Lumina heat transfer product features a pearlescent finish for vibrant designs.

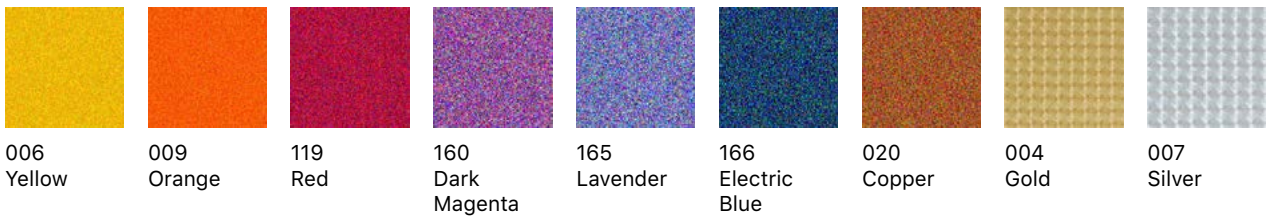

## 9201 Animal Print Heat Transfer Film

product features a matte finish with unique animal print patterns for decorative graphics.

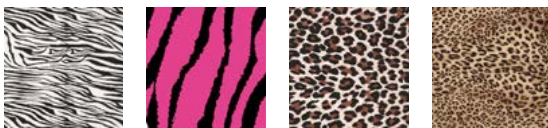

003 Zebra  
076 Pink Zebra  
008 Leopard  
047 Panther

## 9202 Camouflage Heat Transfer Film

product features a matte finish with unique camouflage patterns for decorative graphics.

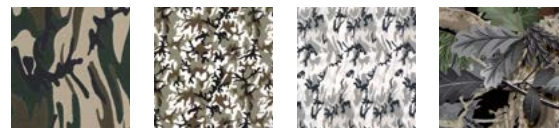

024 Army Camo  
142 Camo  
028 Gray Camo  
052 Gray Oak

## 9204 Textured Heat Transfer Film

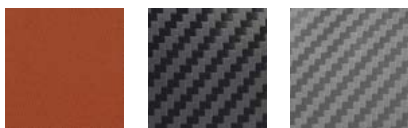

133 Basketball  
040 Black Carbon Fiber  
007 Silver Carbon Fiber

product features a matte finish with unique printed patterns for decorative graphics.

| Film Technology | Thickness (mil) | CPSIA Compliant | Cotton | Polyester | Layerable | 15" x 5 yd | 15" x 10 yd | 15" x 11 yd | 15" x 22 yd | 15" x 25 yd | 15" x 50 yd | Press | Lumina Series     |
|-----------------|-----------------|-----------------|--------|-----------|-----------|------------|-------------|-------------|-------------|-------------|-------------|-------|-------------------|
| Polyurethane    | 3.5             | Yes             | ●      | ●         | ●         | ✓          | ✓           |             |             | ✓           | ✓           | Hot   | 9107 Hot Metallic |
|                 | 2.4             | No              | ●      | ●         |           | ✓          |             |             | ✓           |             |             |       | 9201 Animal       |
|                 | 2.4             | No              | ●      | ●         |           | ✓          |             |             | ✓           |             |             |       | 9202 Camo         |
|                 | 2.4             | No              | ●      | ●         |           | ✓          |             | ✓           | ✓           |             |             |       | 9204 Textured     |

PRINT HTV FILMS

# Lumina

by FDC

## 9300 SERIES 002 Gloss White

Gloss / PVC  
Most versatile on textiles (not acrylic)



## 9302 SERIES

### 000 Matte Clear

Clear PVC  
For white/light colored Textiles / CPSIA



## 9304 SERIES

### 049 Matte White Polyurethane CPSIA



## 9305 SERIES

### 049 Matte White

Premium Polyurethane  
Can be used on acrylics



## 9308 SERIES

### 049 Matte White Matte PVC 6 mil Thickness



PRINT HTV FILMS



9302  
SERIES

| Film | Thickness (mil) | CPSIA Compliant | Cotton | Polyester | Spandex | Leather | Nylon | Layerable | 15" x 5 yd | 15" x 10 yd | 15" x 22' | 15" x 25 yd | 15" x 50 yd | 15" x 66' | 20" x 5 yd | 20" x 10 yd | 20" x 22' | 20" x 25 yd | 20" x 50 yd | 20" x 66' | 29" x 5 yd | 29" x 10 yd | 29" x 25 yd | 29" x 50 yd | 30" x 22' | 30" x 66' | 54" x 22' | 54" x 25 yd | 54" x 50 yd | 54" x 66' | Press                       | Printing             | Lumina Series |
|------|-----------------|-----------------|--------|-----------|---------|---------|-------|-----------|------------|-------------|-----------|-------------|-------------|-----------|------------|-------------|-----------|-------------|-------------|-----------|------------|-------------|-------------|-------------|-----------|-----------|-----------|-------------|-------------|-----------|-----------------------------|----------------------|---------------|
| PVC  | 4.7             | No              | ●      | ●         | ●       | ●       | ●     | ●         | ✓          | ✓           | ✓         | ✓           |             |           |            |             |           |             |             |           | ✓          | ✓           | ✓           | ✓           |           |           |           |             |             |           | Hot or Cold                 | Latex, Eco-Solvent   | 9300          |
| PVC  | 1.8             | Yes             | ●      | ●         |         |         |       |           | ✓          | ✓           | ✓         | ✓           |             |           | ✓          | ✓           |           | ✓           | ✓           |           | ✓          | ✓           | ✓           | ✓           |           |           |           |             |             |           | Hot                         | Solvent, Eco-Solvent | 9302          |
| Poly | 3.1             | No              | ●      | ●         | ●       |         |       |           |            |             | ✓         | ✓           |             |           |            |             | ✓         | ✓           |             |           |            |             | ✓           | ✓           |           |           | ✓         | ✓           |             | Hot       | Solvent, Eco-Solvent        | 9304                 |               |
| Poly | 2               | No              | ●      |           | ●       |         |       |           |            | ✓           |           | ✓           |             |           | ✓          |             |           | ✓           |             |           |            |             |             | ✓           | ✓         | ✓         |           | ✓           |             | Hot       | Latex, Solvent, Eco-Solvent | 9305                 |               |
| PVC  | 6               | No              | ●      | ●         |         |         |       |           |            | ✓           |           | ✓           |             |           | ✓          |             |           | ✓           |             |           |            |             |             |             |           |           |           |             |             | Hot       | Latex, Eco-Solvent          | 9308                 |               |



9010  
OPAQUE



9010  
QUICKPRESS



9004  
STRETCH



9300  
SERIES



# SW 900

## 415 Red

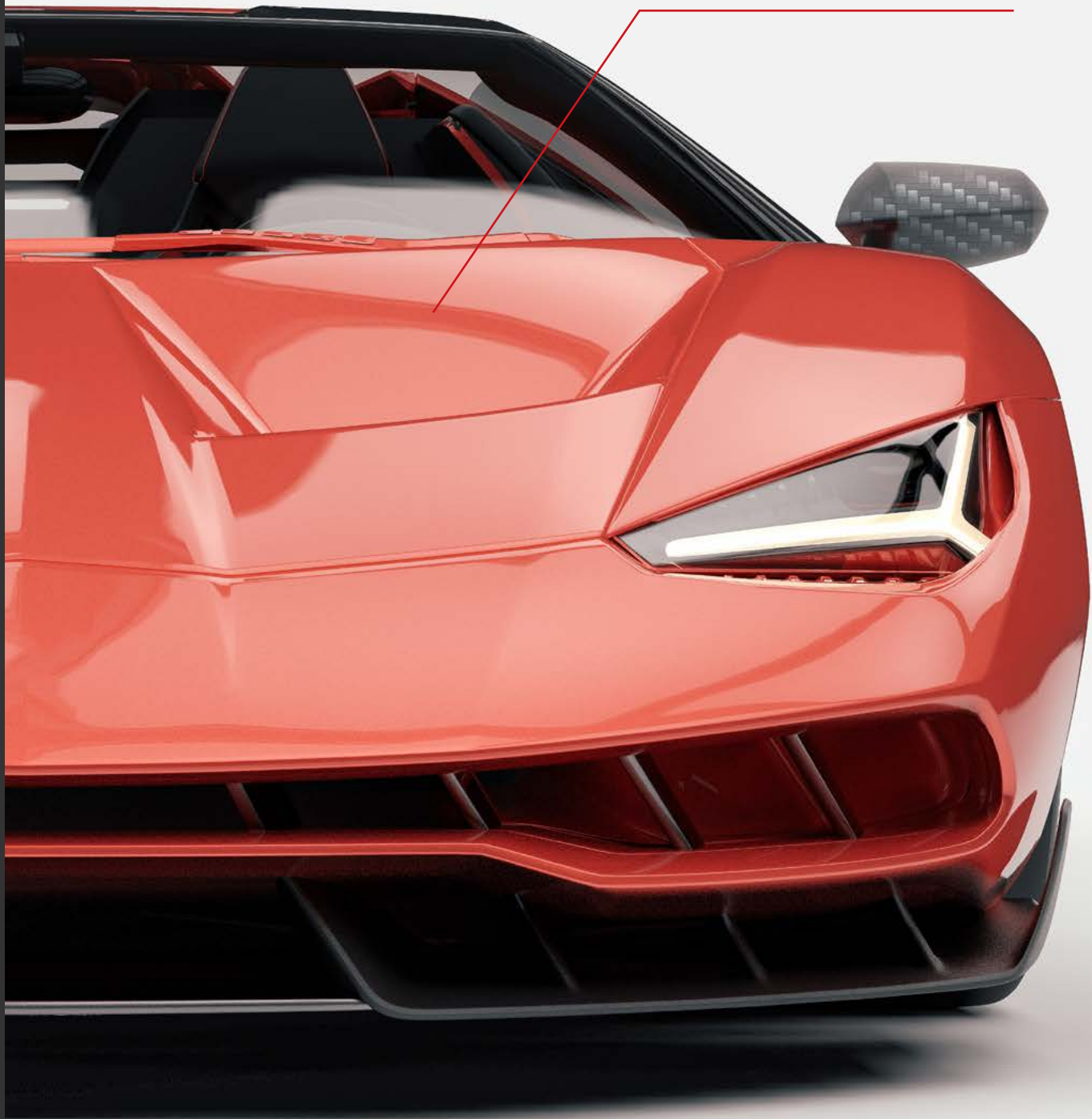



# Vehicle Wrap Vinyl

## **VEHICLE WRAP**

---

|                             |    |
|-----------------------------|----|
| 3M 2080 Series              | 70 |
| 3M 1080 Series              | 71 |
| Avery Dennison SW900 Series | 72 |
| Avery Dennison SW100 Series | 73 |

## **VEHICLE PROTECTION**

---

|   |    |
|---|----|
| Avery Dennison SPF 1000 Surface Gloss Ultra | 74 |
| Avery Dennison SPF 1000 Surface Matte Black | 74 |
| Avery Dennison SPF 1000 Surface Gloss Black | 74 |

## **APPLICATION FLUIDS & VINYL CARE**

---

|              |    |
|--------------|----|
| RapidTac     | 75 |
| RapidTac2    | 75 |
| RapidRemove  | 75 |
| RapidPrep    | 75 |
| RapidClear   | 75 |
| AverySealant | 75 |
| AveryCleaner | 75 |
| AveryPower   | 75 |

CAST VINYL



**2080 Series Wrap Film**

comes with a Protective Film Layer, which can be removed quickly, easily and cleanly after install, reducing surface impressions and scratches for a beautiful finish.



















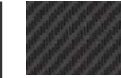

Vehicle Wrap

|                      |                   |                  |                         |                        |                        |                     |                         |                        |                       |
|----------------------|-------------------|------------------|-------------------------|------------------------|------------------------|---------------------|-------------------------|------------------------|-----------------------|
| <b>Gloss</b>         |                   |                  |                         |                        |                        |                     |                         |                        |                       |
|                      | 012 Black         | 013 Hot Rod Red  | 015 Bright Yellow       | 031 Storm Gray         | 440 White Gold Sparkle | 010 White           | 014 Burnt Orange        | 016 Light Green        | 024 Deep Orange       |
|                      |                   |                  |                         |                        |                        |                     |                         |                        |                       |
| 025 Sunflower Yellow | 030 Blue Metallic | 047 Intense Blue | 053 Flame Red           | 054 Bright Orange      | 055 Lucid Yellow       | 077 Sky Blue        | 079 Light Ivory         | 083 Dark Red           | 099 Black Rose        |
|                      |                   |                  |                         |                        |                        |                     |                         |                        |                       |
| 103 Hot Pink         | 127 Boat Blue     | 203 Red Metallic | 212 Black Metallic      | 217 Deep Blue Metallic | 272 Midnight Blue      | 278 Flip Deep Space | 281 Flip Psychedelic    | 292 Galaxy Black       | 298 Gloss Wicked      |
|                      | <b>Matte</b>      |                  |                         |                        |                        |                     |                         |                        |                       |
| 380 Flip Ghost Pearl |                   | 020 White        | 022 Black               | 009 Orange             | 021 Silver             | 026 Military Green  | 027 Indigo              | 052 Dark Gray          | 067 Riviera Blue      |
|                      |                   |                  |                         |                        |                        |                     |                         |                        |                       |
| 121 Gray Aluminum    | 122 Deep Black    | 196 Apple Green  | 206 Pine Green Metallic | 209 Brown Metallic     | 227 Blue Metallic      | 229 Copper Metallic | 263 Red                 | 303 Red Metallic       | 411 Charcoal Metallic |
|                      | <b>Satin</b>      |                  |                         |                        |                        |                     |                         |                        |                       |
| 412 Dead Matte Black |                   | 049 White        | 051 Battleship Gray     | 057 Key West           | 059 Caramel Luster     | 090 Pearl White     | 236 Flip Volcanic Flare | 261 Dark Gray Metallic | 273 Vampire Red       |
|                      |                   |                  |                         |                        |                        |                     |                         |                        |                       |
| 276 Flip Caribbean   | 277 Glacial Frost | 280 Ghost Pearl  | 296 Apple Green         | 312 Satin Black        | 340 Frozen Vanilla     | 342 Dust Black      | 347 Perfect Blue        | 381 Flip Psychedelic   | 427 Ocean Shimmer     |



### 3M 2080 Series Wrap Film

|   |   |   |   |   |   |  |   |   |   |
|---|---|---|---|---|---|--|---|---|---|
|  |  |  |  |  |  |  |  |  |  |
| 435<br>Bitter<br>Yellow   | 444<br>Copper<br>Canyon   | 463<br>Smoldering<br>Red  | Brushed<br>Metallic   | 195<br>Black<br>Metallic  | 201<br>Steel  | 120<br>Aluminum  | 230<br>Titanium   | Carbon<br>Fiber   | 040<br>Black  |
|  |  |  |  |  |  |  |  |  |   |
| 050<br>Anthracite   | 102<br>White  | Matrix<br>Finish  | 612<br>Black  | Shadow<br>Finish  | 512<br>Black  | 626<br>Military<br>Green   | Gloss<br>Chrome   | 451<br>Gloss<br>Chrome  |   |

- Multi-layer, cast vinyl wrap in more than 100 colors
- Protective Film Layer (Gloss Films) prevents damage during installation
- 3M™ Controltac™ technology for easy sliding, tacking, snap-up and repositioning
- Available in 8 styles: Matte, Matte Metallic, Satin, Gloss, Gloss Metallic, Carbon Fiber
- Brushed and Color Flip
- Pressure-sensitive adhesives
- Invisible, air-drain Comply™ technology for bubble-free results



281  
Gloss  
Flip Psychedelic

### 3M 1080 Series Wrap Film

|   |   |   |   |   |   |  |   |   |   |
|---|---|---|---|---|---|--|---|---|---|
|  |  |  |  |  |  |  |  |  |  |
| Gloss   | 012<br>Black  | 030<br>Blue<br>Metallic   | 120<br>White<br>Aluminum  | 212<br>Black<br>Metallic  | 258<br>Gloss Plum<br>Explosion  | 377<br>Cosmic<br>Blue  | 378<br>Blue<br>Raspberry  | Satin   | 463<br>Smoldering<br>Red  |
|  |  |  |  |  |  |  |  |  |  |
| Matte   | 022<br>Black  | 052<br>Dark<br>Gray   | 121<br>Gray<br>Aluminum   | 206<br>Pine Green<br>Metallic   | 227<br>Blue<br>Metallic   | Brushed<br>Metallic  | 204<br>Gold   | Carbon<br>Fiber   | 040<br>Black  |

SW900 Supreme Wrapping™



SW900  
Supreme  
Wrapping™



| Area of Use | Common Applications | Durability | Dimensions |
|-------------|---------------------|------------|------------|
|-------------|---------------------|------------|------------|

- Flat Surfaces
- Flat with Rivets
- Corrugations
- Deep Recesses
- Indoor & Outdoor

- Cars
- Buses
- Emergency Vehicles
- Trailers

- 2 years

Width  
60"  
Length  
5 yd, 25 yd

| ColorFlow™ | 251<br>Satin Gold<br>/ Silver | 446<br>Satin Red<br>/ Gold | 551<br>Satin Blue<br>/ Red | 610<br>Satin Green<br>/ Purple | 673<br>Satin Cyan<br>/ Purple | 786<br>Satin Silver<br>/ Green | 789<br>Hidden<br>Forest |
|------------|-------------------------------|----------------------------|----------------------------|--------------------------------|-------------------------------|--------------------------------|-------------------------|
|            | 252<br>Gloss Gold<br>/ Silver | 447<br>Gloss Red<br>/ Gold | 552<br>Gloss Blue<br>/ Red | 611<br>Gloss Green<br>/ Purple | 674<br>Gloss Cyan<br>/ Purple | 787<br>Gloss Silver<br>/ Green |                         |

| Gloss | 101<br>White | 190<br>Black | 191<br>Obsidian<br>Black | 235<br>Yellow | 236<br>Ambulance<br>Yellow | 249<br>Dark<br>Yellow | 373<br>Orange | 415<br>Red | 427<br>Soft<br>Red |
|-------|--------------|--------------|--------------------------|---------------|----------------------------|-----------------------|---------------|------------|--------------------|
|-------|--------------|--------------|--------------------------|---------------|----------------------------|-----------------------|---------------|------------|--------------------|

|                        |                       |                 |                       |                      |                     |                           |                       |                        |             |
|------------------------|-----------------------|-----------------|-----------------------|----------------------|---------------------|---------------------------|-----------------------|------------------------|-------------|
| 433<br>Cardinal<br>Red | 436<br>Carmine<br>Red | 475<br>Burgundy | 612<br>Smokey<br>Blue | 632<br>Light<br>Blue | 636<br>Aqua<br>Blue | 648<br>Sea Breeze<br>Blue | 656<br>Cloudy<br>Blue | 667<br>Intense<br>Blue | 677<br>Blue |
|------------------------|-----------------------|-----------------|-----------------------|----------------------|---------------------|---------------------------|-----------------------|------------------------|-------------|

|                     |                       |                           |                      |                      |                     |             |                     |
|---------------------|-----------------------|---------------------------|----------------------|----------------------|---------------------|-------------|---------------------|
| 681<br>Dark<br>Blue | 699<br>Indigo<br>Blue | 728<br>Light<br>Pistachio | 731<br>Lime<br>Green | 792<br>Dark<br>Green | 821<br>Rock<br>Gray | 832<br>Gray | 865<br>Dark<br>Gray |
|---------------------|-----------------------|---------------------------|----------------------|----------------------|---------------------|-------------|---------------------|

| Gloss Metallic | 184<br>Mystery<br>Black | 192<br>Black | 199<br>Eclipse | 215<br>Gold | 255<br>Sand<br>Sparkle | 419<br>Spark | 646<br>Bright<br>Blue | 653<br>Dark<br>Blue | 679<br>Magnetic<br>Burst |
|----------------|-------------------------|--------------|----------------|-------------|------------------------|--------------|-----------------------|---------------------|--------------------------|
|----------------|-------------------------|--------------|----------------|-------------|------------------------|--------------|-----------------------|---------------------|--------------------------|





**SW900 Supreme Wrapping™**

|                                  |                                  |                                 |                         |                        |                                   |                           |                              |                          |                                |
|----------------------------------|----------------------------------|---------------------------------|-------------------------|------------------------|-----------------------------------|---------------------------|------------------------------|--------------------------|--------------------------------|
|                                  |                                  |                                 |                         |                        |                                   |                           |                              |                          |                                |
| 700<br>Mysterious<br>Indigo      | 762<br>Radioactive               | 803<br>Silver                   | 807<br>Gray             | 816<br>Quick<br>Silver | 879<br>Pride<br>Prismatic<br>Gray | 929<br>Brown              | Matte                        | 102<br>White             | 180<br>Black                   |
|                                  |                                  |                                 |                         |                        |                                   |                           |                              |                          |                                |
| 321<br>Orange                    | 711<br>Khaki                     | 732<br>Olive<br>Green           | 856<br>Dark<br>Gray     | Matte<br>Metallic      | 472<br>Garnet<br>Red              | 520<br>Pink               | 565<br>Purple                | 615<br>Blue              | 623<br>Night<br>Blue           |
|                                  |                                  |                                 |                         |                        |                                   |                           |                              |                          |                                |
| 643<br>Frosty<br>Blue            | 745<br>Apple<br>Green            | 737<br>Moss<br>Green            | 857<br>Silver           | 845<br>Charcoal        | 845<br>Charcoal                   | Diamond                   | 161<br>White                 | 221<br>Amber             | 426<br>Red                     |
|                                  |                                  |                                 |                         |                        |                                   |                           |                              |                          |                                |
| 587<br>Purple                    | 676<br>Blue                      | 878<br>Silver                   | Special<br>Effects      | 448<br>Passion<br>Red  | 568<br>Fun<br>Purple              | 316<br>Stunning<br>Orange | 261<br>Energetic<br>Yellow   | 767<br>Hope<br>Green     | 716<br>Cool<br>Teal            |
|                                  |                                  |                                 |                         |                        |                                   |                           |                              |                          |                                |
| 629<br>Wave<br>Blue              | Extreme<br>Texture               | 115<br>Carbon<br>Fiber<br>White | 193<br>Brushed<br>Black | 194<br>Carbon<br>Fiber | 933<br>Bronze                     | 813<br>Steel              | 812<br>Aluminum              | 802<br>Titanium          | 182<br>Rugged<br>Onyx<br>Black |
|                                  |                                  |                                 |                         |                        |                                   |                           |                              |                          |                                |
| 718<br>Rugged<br>Combat<br>Green | 824<br>Rugged<br>Bedrock<br>Gray | 738<br>Rugged<br>Mash<br>Green  | Satin                   | 116<br>White           | 197<br>Black                      | 224<br>Yellow             | 438<br>Carmine<br>Red        | 514<br>Bubblegum<br>Pink | 633<br>Light<br>Blue           |
|                                  |                                  |                                 |                         |                        |                                   |                           |                              |                          |                                |
| 682<br>Dark<br>Blue              | 833<br>Gray                      | 712<br>Khaki<br>Green           | 854<br>Dark<br>Gray     | Satin<br>Metallic      | 566<br>Purple                     | 260<br>Safari<br>Gold     | 823<br>Black<br>Rock<br>Gray | 805<br>Silver            | 871<br>Dark<br>Basalt          |
|                                  |                                  |                                 |                         |                        |                                   |                           |                              |                          |                                |
| Pearl                            | 117<br>Pearl<br>White            | 109<br>White                    | 777<br>Light<br>Green   | 796<br>Dark<br>Green   |                                   |                           |                              |                          |                                |

**SW100 Conform Chrome** Easy Apply™ RS

|        |                     |               |                          |                        |             |            |             |              |
|--------|---------------------|---------------|--------------------------|------------------------|-------------|------------|-------------|--------------|
|        |                     |               |                          |                        |             |            |             |              |
| Chrome | 211<br>Rose<br>Gold | 510<br>Violet | 843<br>Chrome/<br>Silver | 844<br>Matte<br>Silver | 604<br>Gold | 474<br>Red | 256<br>Blue | 196<br>Black |



**PAINT PROTECTION**



**Supreme Defense™  
Paint Protection  
Films**



**SPF 1000 Surface  
Gloss Ultra Clear  
Protection Film**

- ▶ Up to 10 year durability
- ▶ Provides surface protection with
- ▶ Heat activated self-healing
- ▶ Dimensionally stable liner for easy converting
- ▶ Suitable for curved applications
- ▶ UV stability

**SPF 1000 Surface  
Matte Clear  
Protection Film**

- ▶ Up to 5 year durability
- ▶ Provides surface protection with
- ▶ Heat activated self-healing
- ▶ Dimensionally stable liner for easy converting
- ▶ Suitable for curved applications
- ▶ UV stability

**SPF 1000 Surface  
Gloss Black  
Protection Film**

- ▶ Up to 5 year durability
- ▶ Provides surface protection with
- ▶ Heat activated self-healing
- ▶ Dimensionally stable liner for easy converting
- ▶ Suitable for curved applications
- ▶ UV stability



## APPLICATION FLUIDS & VINYL CARE



### RapidTac Application Fluids & Vinyl Care



| Item #   | RAPIDTAC                                | Item #   | RAPIDTAC2                                 | Item #   | RAPIDREMOVE                             | Item #   | RAPIDPREP                               | Item #   | RAPIDCLEAR                              |
|----------|---|----------|---|----------|---|----------|---|----------|---|
|          |   |          |   |          |   |          |   |          |   |
|          | <b>Rapid Tac<br/>Application Fluid</b>  |          | <b>Rapid Tac II<br/>Application Fluid</b> |          | <b>Rapid Tac<br/>Rapid Remover</b>      |          | <b>Rapid Tac<br/>Rapid Prep</b>         |          | <b>Rapid Tac<br/>Rapid Clear</b>        |
| Bottle   | 4 oz.<br>32 oz.<br>1 Gallon<br>5 Gallon | Bottle   | 4 oz.<br>32 oz.<br>1 Gallon<br>5 Gallon   | Bottle   | 4 oz.<br>32 oz.<br>1 Gallon<br>5 Gallon | Bottle   | 4 oz.<br>32 oz.<br>1 Gallon<br>5 Gallon | Bottle   | 4 oz.<br>32 oz.<br>1 Gallon<br>5 Gallon |
| Used for | Standard<br>Cast Films                  | Used for | Premium<br>Cast Films                     | Used for | Adhesive<br>Removal                     | Used for | Preparing<br>Surface                    | Used for | Clean &<br>Polish                       |



Graphics  
Solutions

## Aver Dennison Vinyl Care



| Item # | AVERYSEALANT   | Item # | AVERYSSEALANT   | Item # | AVERYPOLISH                                    |
|--------|--|--------|---|--------|--|
|        |  |        |   |        |  |
|        | <b>Sealant for<br/>Car Wraps</b>                       |        | <b>Power<br/>Cleaner</b>                                      |        | <b>Cleaner for<br/>Car Wraps</b>               |
|        | 32 oz.<br>Provides a protective<br>layer on your wrap. |        | 32 oz.<br>Cleaning product for<br>difficult localized stains. |        | 32 oz.<br>Cleaning product for<br>regular use. |





TT-0101  
Heat Gun  
p 91



WG-0101  
Sheet Clip  
p 91

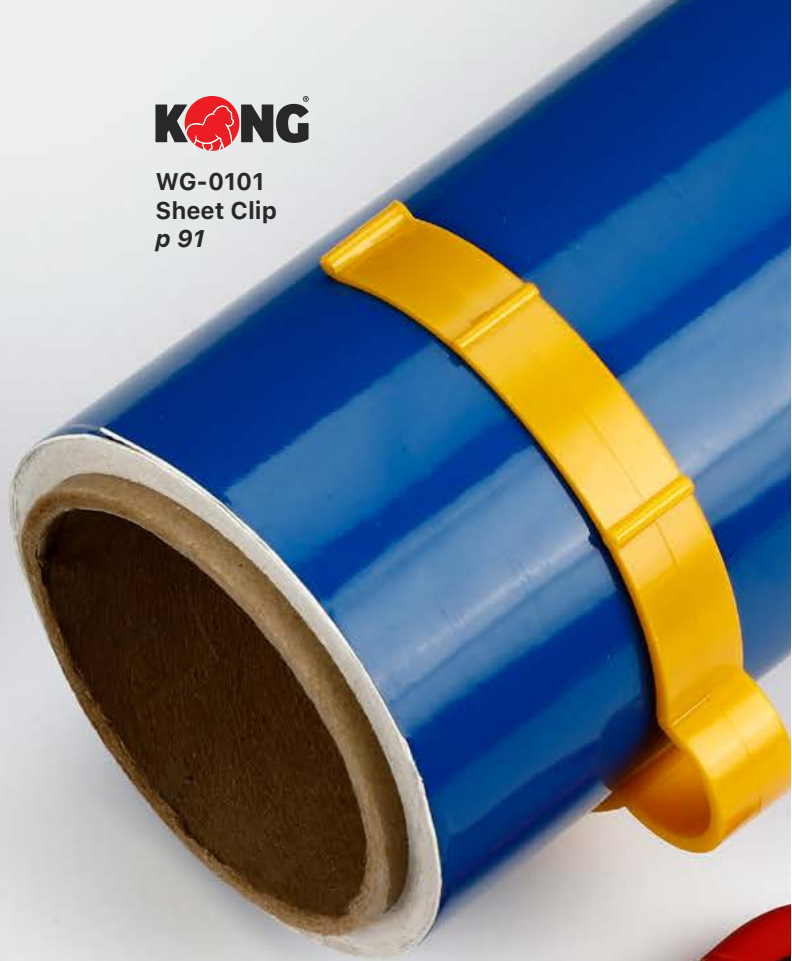

SQ-0104  
Squeegee  
p 85



SQ-0217  
Tucking Squeegee  
p 86



CT-0104  
Precision Knife  
p 78



SP-0107  
Scraper  
p 90



WG-0101  
Wrapping Gloves  
p 89



# Wrap Tools



## CUTTERS

|                                    |    |
|------------------------------------|----|
| Precision Knives & Art Blades      | 78 |
| Vinyl Bodyguard Back Paper Cutters | 78 |
| Knifeless Tape                     | 79 |
| Disposal Boxes                     | 79 |
| Spare Blades                       | 79 |
| Olfa Cutters                       | 80 |
| Olfa Precision Knives              | 81 |
| Olfa Rotary Cutters                | 81 |
| Olfa Scrapers                      | 81 |
| Olfa Mats                          | 81 |
| Olfa Spare Blades                  | 82 |
| Olfa Disposal Boxes                | 82 |

## SQUEEGEES

|                           |    |
|---------------------------|----|
| Quick Pick Squeegee Guide | 84 |
| Squeegees                 | 85 |
| Specialty Squeegees       | 86 |
| Corner Wrap Squeegees     | 86 |
| Wrap Puller Squeegees     | 87 |
| Specialty Removal Tools   | 87 |
| Squeegee Kits             | 87 |
| Tint Tools                | 88 |
| Vinyl Rollers             | 88 |
| Efficiency Accessories    | 88 |
| Wrap Gloves               | 89 |
| Magnets                   | 89 |
| Knee Pads                 | 89 |
| Tool Pouches              | 89 |

## SCRAPERS

|                      |    |
|----------------------|----|
| Metal Scrapers       | 90 |
| Plastic Scrapers     | 90 |
| Emblem Removal       | 90 |
| Scraper Spare Blades | 90 |

## TOOLS & ELECTRONICS

|                 |    |
|-----------------|----|
| Removal Tools   | 91 |
| Tweezers        | 91 |
| Vinyl Displays  | 91 |
| Heat Guns       | 91 |
| Replacements    | 91 |
| Sheet Clips     | 91 |
| Air Release Pen | 91 |

**PRECISION CUTTERS**



**Our precision cutter knives are specially designed to ergonomically fit into your hand**



**■ Precision Knives**

Item # **CT-0101**

**Standard Duty Slim Line (30°) Precision Knife**

|          |                 |
|----------|-----------------|
| Length   | 5"              |
| Size     | 9mm             |
| Degree   | 30°             |
| Material | Plastic         |
| Lock     | Auto            |
| Blade    | Stainless Steel |

Item # **CT-0104**

**Heavy Duty Slim Line (30°) Precision Knife**

|          |                 |
|----------|-----------------|
| Length   | 5"              |
| Size     | 9mm             |
| Degree   | 30°             |
| Material | Stainless Steel |
| Lock     | Auto            |
| Blade    | Stainless Steel |

Item # **CT-0102**

**Heavy Duty Slim Line (60°) Precision Knife**

|          |                 |
|----------|-----------------|
| Length   | 5"              |
| Size     | 9mm             |
| Degree   | 60°             |
| Material | Stainless Steel |
| Lock     | Auto            |
| Blade    | Stainless Steel |

Item # **CT-0103**

**Heavy Duty Slim Line (60°) Precision Knife**

|          |                 |
|----------|-----------------|
| Length   | 5"              |
| Size     | 9mm             |
| Degree   | 60°             |
| Material | Stainless Steel |
| Lock     | Manual          |
| Blade    | Stainless Steel |

**■ Art Blades**

Item # **CT-0401**

**(30°) Exacto Knife**

|              |           |
|--------------|-----------|
| Length       | 6"        |
| Degree       | 30°       |
| Material     | Aluminum  |
| Color        | Gray      |
| Type         | Art Blade |
| Spare Blades | 5         |

Item # **CT-0402**

**2 in 1 Multi Function (30°) Exacto Knife**

|              |           |
|--------------|-----------|
| Length       | 7"        |
| Degree       | 30°       |
| Material     | Plastic   |
| Color        | Yellow    |
| Type         | Art Blade |
| Spare Blades | 5         |

Item # Clear  **CT-0201**  
 Gray  **CT-0202**  
 Orange  **CT-0203**

**Vinyl Bodyguard Back Paper Cutters**

|                |                 |
|----------------|-----------------|
| Length         | 5 1/2"          |
| Material       | Plastic         |
| Blade Type     | Art Blade       |
| Blade Material | Stainless Steel |
| Spare Blades   | No              |

Item # Orange  **CT-0301**  
 Black  **CT-0302**

**4" Vinyl Safety Cutters**

|                |                 |
|----------------|-----------------|
| Length         | 4"              |
| Material       | Plastic         |
| Blade Type     | Art Blade       |
| Blade Material | Stainless Steel |
| Spare Blades   | No              |

Wrap Tools



Precision Cutters

Vinyl Bodyguard Back Paper Cutters

Item # **CT-0204**  
**CT-0205**



**Metal Vinyl Bodyguard Back Paper Cutter**

|             |                 |
|-------------|-----------------|
| Length      | 4 1/2"          |
| Material    | Metal           |
| Color       | Black           |
| Blade       | Stainless Steel |
| Spare Blade | CT-0506         |

Item # **CT-0206**



**Twin Blade Metal Vinyl Bodyguard Back Paper Cutter**

|             |                 |
|-------------|-----------------|
| Length      | 5"              |
| Material    | Rubber          |
| Color       | Gray            |
| Blade       | Stainless Steel |
| Spare Blade | CT-0506         |

Item # **CT-0209**



**Twin Blade Metal Vinyl Bodyguard Back Paper Cutter (Adjustable)**

|             |                 |
|-------------|-----------------|
| Length      | 5 1/2"          |
| Material    | Stainless Steel |
| Color       | Gray            |
| Blade       | Stainless Steel |
| Spare Blade | CT-0506         |

Item # **CT-0207**



**8" Metal Vinyl Bodyguard Back Paper Cutter**

|             |                 |
|-------------|-----------------|
| Length      | 8"              |
| Material    | Metal           |
| Color       | Black           |
| Blade       | Stainless Steel |
| Spare Blade | CT-0506         |

Item # **CT-0208**



**23" Metal Vinyl Bodyguard Back Paper Cutter**

|             |                 |
|-------------|-----------------|
| Length      | 23"             |
| Material    | Metal           |
| Color       | Black           |
| Blade       | Stainless Steel |
| Spare Blade | CT-0506         |

Knifeless Tape

Item # **CT-0701**



**164' of Knifeless Tape**

|          |        |
|----------|--------|
| Length   | 164'   |
| Material | String |
| Color    | Green  |

Disposal Boxes

Item # **CT-0601**



**Yellow Pocket Size Blade Disposal Box**

|          |         |
|----------|---------|
| Length   | 3 1/2"  |
| Width    | 1"      |
| Material | Plastic |
| Color    | Yellow  |

Item # **CT-0602**



**Gray Pocket Size Blade Disposal Box**

|          |         |
|----------|---------|
| Length   | 3"      |
| Width    | 1 3/4"  |
| Material | Plastic |
| Color    | Gray    |

Item # **CT-0603**



**Yellow Pocket Size Blade Disposal Box**

|          |         |
|----------|---------|
| Length   | 3 1/2"  |
| Width    | 1"      |
| Material | Plastic |
| Color    | Yellow  |

Spare Blades

Item # **CT-0506**



**Carbon Steel Blades for Razor Scraper**

|          |                 |
|----------|-----------------|
| Length   | 1 1/2"          |
| Width    | 1"              |
| Material | Stainless Steel |
| Color    | Gray            |

Spare Blades

Item # **CT-0502**



**30° 9mm Carbon Steel Snap Blade**

|          |              |
|----------|--------------|
| Size     | 9mm          |
| Degree   | 30°          |
| Material | Carbon Steel |
| Color    | Gray         |
| Pack     | 10 Blades    |

Item # **CT-0505**



**30° 9mm Carbon Steel Snap Blade**

|          |              |
|----------|--------------|
| Size     | 9mm          |
| Degree   | 30°          |
| Material | Carbon Steel |
| Color    | Gray         |
| Pack     | 50 Blades    |

Item # **CT-0501**



**60° 9mm Carbon Steel Snap Blade**

|          |              |
|----------|--------------|
| Size     | 9mm          |
| Degree   | 60°          |
| Material | Carbon Steel |
| Color    | Gray         |
| Pack     | 10 Blades    |

Item # **CT-0503**



**60° 9mm Stainless Steel Snap Blade**

|          |                 |
|----------|-----------------|
| Size     | 9mm             |
| Degree   | 60°             |
| Material | Stainless Steel |
| Color    | Gray            |
| Pack     | 50 Blades       |

Item # **CT-0504**



**60° 9mm Carbon Steel Snap Blade**

|          |              |
|----------|--------------|
| Size     | 9mm          |
| Degree   | 60°          |
| Material | Carbon Steel |
| Color    | Gray         |
| Pack     | 50 Blades    |

Precision Cutters

Cutters

Item # **CT-0105**

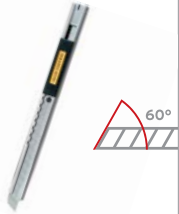

**Heavy Duty Slide Lock (60°) Precision Knife**

Size 9mm  
Degree 60°  
Material Stainless Steel  
Color Gray  
Blade Abs Stainless Steel

Item # **CT-0106**



**Heavy Duty Auto Lock (60°) Precision Knife**

Size 9mm  
Degree 60°  
Material Stainless Steel  
Color Gray  
Blade Abs Stainless Steel

Item # **CT-0107**

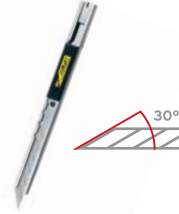

**Heavy Duty Auto Lock (30°) Precision Knife**

Size 9mm  
Degree 30°  
Material Stainless Steel  
Color Gray  
Blade Carbon Steel

Item # **CT-0108**



**Heavy Duty Fiberglass Auto Lock (60°) Precision Knife**

Size 9mm  
Degree 60°  
Material Fiberglass  
Color Yellow & Black  
Blade Japanese Carbon Steel

Item # **CT-0109**



**Classic Plastic Slide Lock (60°) Precision Knife**

Size 9mm  
Degree 60°  
Material Plastic  
Color Yellow & Black  
Blade Japanese Steel

Item # **CT-0110**



**Classic Plastic Slide Lock (60°) Precision Knife**

Size 9mm  
Degree 60°  
Material Plastic  
Color Yellow & Black  
Blade Japanese Carbon Steel

Item # **CT-0111**



**Classic Silicone Auto Lock (60°) Precision Knife**

Size 9mm  
Degree 60°  
Material Silicone  
Color Gray  
Blade Japanese Carbon Steel

Item # **CT-0112**



**Classic Metal Auto Lock (60°) Precision Knife**

Size 9mm  
Degree 60°  
Material Metal  
Color Blue  
Blade Japanese Steel

Item # **CT-0113**



**ECO-Friendly Recycled Auto Lock (60°) Precision Knife**

Size 9mm  
Degree 60°  
Material Recycle  
Color Blue  
Blade Japanese Steel

Item # **CT-0114**



**Heavy Duty Plastic Screw Lock (60°) Precision Knife**

Size 9mm  
Degree 60°  
Material Plastic  
Color Yellow  
Blade Japanese Steel

Item # **CT-0117**



**Heavy Duty Extended Shaft Screw Lock (60°) Precision Knife**

Size 9mm  
Degree 60°  
Material Plastic  
Color Yellow  
Blade Japanese Steel

Item # **CT-0118**

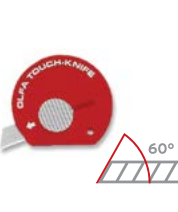

**Circular Keychain Multi Purpose (60°) Knife**

Size 9mm  
Degree 60°  
Material Plastic  
Color Red  
Blade Japanese Steel

Item # **CT-0115**



**Heavy Duty Plastic Screw Lock (60°) Precision Knife**

Size 18mm  
Degree 60°  
Material Plastic  
Color Yellow  
Blade Japanese Steel

Item # **CT-0116**



**Heavy Duty Plastic Auto Lock (60°) Precision Knife**

Size 18mm  
Degree 60°  
Material Plastic  
Color Yellow  
Blade Japanese Steel

Item # **CT-0210**



**Auto Pressure Back Paper Cutter**

Size 9mm  
Degree 45°  
Material Plastic  
Color Gray  
Blade Top Sheet Blade



Precision Cutters

■ Precision Knives

Item # **CT-0303**



**Circular Safety Cutter**

|          |         |
|----------|---------|
| Size     | 9mm     |
| Degree   | 360°    |
| Material | Plastic |
| Color    | Yellow  |
| Blade    | Carbide |

Item # **CT-0403**

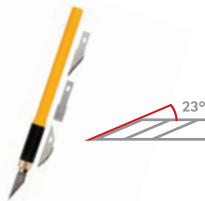

**High Precision (23°) Art Knife**

|          |              |
|----------|--------------|
| Size     | 9mm          |
| Degree   | 23°          |
| Material | Plastic      |
| Color    | Yellow       |
| Blade    | Carbon Steel |

Item # **CT-0404**



**High Precision (23°) Art Knife with Quick Spin Blade**

|          |              |
|----------|--------------|
| Size     | 9mm          |
| Degree   | 23°          |
| Material | Plastic      |
| Color    | Yellow       |
| Blade    | Carbon Steel |

■ Rotary Cutters

Item # **CT-0801**



**45mm Ergonomic Self-Retracting Rotary Cutter**

|          |                |
|----------|----------------|
| Size     | 45mm           |
| Degree   | 360°           |
| Material | Plastic        |
| Color    | Yellow & Black |
| Blade    | Tungsten Steel |

Item # **CT-0802**



**60mm Ergonomic Self-Retracting Rotary Cutter**

|          |                |
|----------|----------------|
| Size     | 60mm           |
| Degree   | 360°           |
| Material | Plastic        |
| Color    | Yellow & Black |
| Blade    | Tungsten Steel |

Item # **CT-0803**



**45mm Straight Handle Standard Rotary Cutter**

|          |                |
|----------|----------------|
| Size     | 45mm           |
| Degree   | 360°           |
| Material | Plastic        |
| Color    | Yellow & Black |
| Blade    | Tungsten Steel |

Item # **CT-0804**



**60mm Straight Handle Standard Rotary Cutter**

|          |                |
|----------|----------------|
| Size     | 60mm           |
| Degree   | 360°           |
| Material | Plastic        |
| Color    | Yellow & Black |
| Blade    | Tungsten Steel |

Item # **CT-0119**



**Heavy Duty Circular Cutter (Cuts Circles 3"-12")**

|          |                |
|----------|----------------|
| Size     | 19mm           |
| Degree   | 30°            |
| Material | Plastic        |
| Color    | Yellow & Black |
| Blade    | Carbon Steel   |

Item # **CT-0109**



**1 1/2" Metal Scraper with Blade Holder Fiberglass Reinforced**

|          |                 |
|----------|-----------------|
| Size     | 1 1/2"          |
| Degree   | Fiberglass      |
| Material | Single          |
| Color    | Yellow & Black  |
| Blade    | Stainless Steel |

Item # **CT-0110**



**4 3/4" Multi-Grip Scraper Safety Blade Guard**

|          |                 |
|----------|-----------------|
| Size     | 4 3/4"          |
| Degree   | Fiberglass      |
| Material | Single          |
| Color    | Yellow & Black  |
| Blade    | Stainless Steel |

■ Mats

Item # **CT-0901**



**8" Wide x 6" Long Double-Sided Rotary Mat**

|           |              |
|-----------|--------------|
| Width     | 6"           |
| Height    | 8"           |
| Thickness | 1.5mm        |
| Color     | Green        |
| Material  | Self Healing |
| Use       | Measuring    |

Item # **CT-0902**



**12" Wide x 18" Long Double-Sided Rotary Mat**

|           |              |
|-----------|--------------|
| Width     | 18"          |
| Height    | 12"          |
| Thickness | 1.5mm        |
| Color     | Green        |
| Material  | Self Healing |
| Use       | Measuring    |

Item # **CT-0903**



**18" Wide x 24" Long Double-Sided Rotary Mat**

|           |              |
|-----------|--------------|
| Width     | 24"          |
| Height    | 18"          |
| Thickness | 1.5mm        |
| Color     | Green        |
| Material  | Self Healing |
| Use       | Measuring    |

Item # **CT-0904**

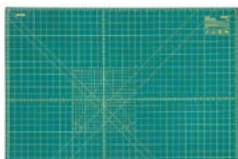

**24" Wide x 36" Long Double-Sided Rotary Mat**

|           |              |
|-----------|--------------|
| Width     | 36"          |
| Height    | 24           |
| Thickness | 1.5mm        |
| Color     | Green        |
| Material  | Self Healing |
| Use       | Measuring    |

Item # **CT-0905**  
**CT-0906**



**Long Double-Sided Rotary Mat**

|           |              |
|-----------|--------------|
| CT-0905   | 70" x 23"    |
| CT-0906   | 70" X 35"    |
| Thickness | 1.5mm        |
| Color     | Green        |
| Material  | Self Healing |
| Use       | Measuring    |



**Precision Cutters**

Item # **CT-0507**  
**CT-0508**



**Olfa 60° 9mm Ultra-Sharp Black Japanese Carbon Blade**

|            |         |
|------------|---------|
| Pack of 10 | CT-0507 |
| Pack of 50 | CT-0508 |
| Degree     | 60°     |
| Size       | 9mm     |

Item # **CT-0509**  
**CT-0510**



**Olfa 60° 9mm Silver Snap-off Japanese Steel Blade**

|            |         |
|------------|---------|
| Pack of 10 | CT-0509 |
| Pack of 50 | CT-0510 |
| Degree     | 60°     |
| Size       | 9mm     |

Item # **CT-0511**



**Olfa 60° 9mm Stainless Steel Snap-off Blade**

|            |         |
|------------|---------|
| Pack of 10 | CT-0511 |
| Degree     | 60°     |
| Size       | 9mm     |

Item # **CT-0512**



**Olfa 60° 9mm Stainless Steel Snap-off Blade**

|         |            |
|---------|------------|
| Package | Pack of 50 |
| Degree  | 60°        |
| Size    | 9mm        |

Item # **CT-0513**



**Olfa 60° 18mm Ultra-Sharp Black Japanese Carbon Blade**

|         |            |
|---------|------------|
| Package | Pack of 10 |
| Degree  | 60°        |
| Size    | 18mm       |

Item # **CT-0514**



**Olfa 60° 18mm Ultra-Sharp Black Japanese Carbon Blade**

|         |            |
|---------|------------|
| Pack of | Pack of 50 |
| Degree  | 60°        |
| Size    | 9mm        |

Item # **CT-0515**



**Olfa 45mm Tungsten Steel Rotary Blade**

|         |      |
|---------|------|
| Pack of | 1    |
| Degree  | 360° |
| Size    | 45mm |

Item # **CT-0516**



**Olfa 45mm Tungsten Steel Rotary Blade**

|         |      |
|---------|------|
| Pack of | 5    |
| Degree  | 360° |
| Size    | 60mm |

Item # **CT-0517**



**Olfa 60mm Tungsten Steel Rotary Blade**

|         |      |
|---------|------|
| Pack of | 1    |
| Degree  | 360° |
| Size    | 60mm |

Item # **CT-0518**



**Olfa 60mm Tungsten Steel Rotary Blade**

|         |      |
|---------|------|
| Pack of | 5    |
| Degree  | 360° |
| Size    | 60mm |

**■ Disposal Cans**

Item # **CT-0519**



**Olfa 23° Precision Art Blade**

|         |     |
|---------|-----|
| Pack of | 5   |
| Degree  | 23° |

Item # **CT-0520**



**Olfa 23° Precision Art Blade**

|         |     |
|---------|-----|
| Pack of | 100 |
| Degree  | 23° |

Item # **CT-0521**



**Olfa 45° Top Sheet Cutter Blade**

|         |     |
|---------|-----|
| Pack of | 5   |
| Degree  | 45° |

Item # **CT-0604**



**Olfa Pocket Sized Blade Disposal Can**

|          |         |
|----------|---------|
| Material | Plastic |
| Color    | Yellow  |
| Utility  | Storage |

Item # **CT-0605**



**Olfa Blade Disposal Can with Easy Snap**

|          |         |
|----------|---------|
| Material | Plastic |
| Color    | Yellow  |
| Utility  | Storage |





**CT-0803**  
Rotary Cutter  
Page 81

**CT-0115**  
Precision Knife  
Page 80



**TT-0101**  
Heat Gun  
Page 91



**CT-0301**  
Safety Cutter  
Page 78



**CT-0401**  
Art Blade  
Page 78



**SP-0106**  
Razor Blade Scraper  
Page 90

## SQUEEGEES



Soft, Medium and Hard vinyl wrap squeegees to ensure flawless, bubble-free vinyl graphic applications with minimal effort!



### Soft

The soft hardness allows for major corner molding along with longterm duration and reusability.

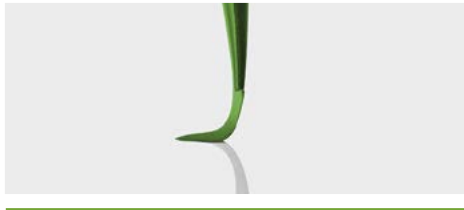

### Medium

The medium hardness allows for fine corner molding along with longterm duration and reusability.

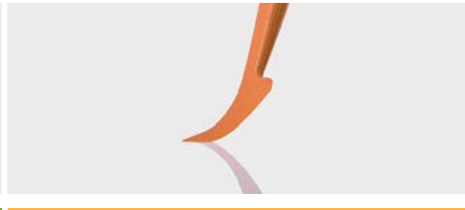

### Hard

The hard hardness allows for precise and consistent strokes along with longterm duration and reusability.

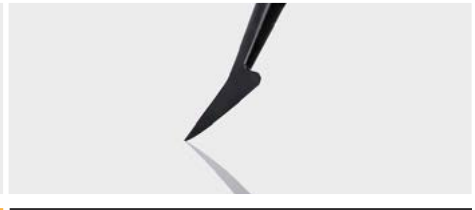

### Felt

Lined with a solid suede felt edge, to ensure no scratches to be transferred on to your vinyl or film.



### Magnetic

This magnet squeegees can help to hold the knife or other metal tools easy to hold.

Squeegees

Item # **SQ-0101**



**4" White Squeegee**

Dimensions 4" x 3"  
 Material Plastic  
 Color White  
 Hardness Medium  
 Fabric No  
 Magnetic No

Item # **SQ-0102**



**4" White Squeegee**

Dimensions 4" x 3"  
 Material Plastic  
 Color White  
 Hardness Soft  
 Fabric No  
 Magnetic No

Item # **SQ-0103**



**4" Blue Squeegee**

Dimensions 4" x 3"  
 Material Plastic  
 Color White  
 Hardness Hard  
 Fabric No  
 Magnetic No

Item # **SQ-0104**



**4" Blue Squeegee**

Dimensions 4" x 3"  
 Material Plastic  
 Color Blue  
 Hardness Medium  
 Fabric Felt  
 Magnetic No

Item # **SQ-0220**



**Gray 90° Squeegee**

Dimensions 3 1/2" x 2"  
 Material Plastic  
 Color Gray  
 Hardness Medium  
 Fabric Felt  
 Magnetic No

Item # **SQ-0221**



**Gray 135° Squeegee**

Dimensions 3 1/2" x 2"  
 Material Plastic  
 Color Gray  
 Hardness Medium  
 Fabric Suede  
 Magnetic No

Item # **SQ-0301**



**4" Black Squeegee**

Dimensions 4" x 3"  
 Material Plastic  
 Color Black  
 Hardness Medium  
 Fabric Felt  
 Magnetic No

Item # **SQ-0302**



**4" Black Squeegee**

Dimensions 4" x 3"  
 Material Plastic  
 Color Black  
 Hardness Medium  
 Fabric Suede  
 Magnetic No

Item # **SQ-0303**



**3M White Wool Squeegee**

Dimensions 2" x 3 1/2"  
 Material Wool  
 Color White  
 Hardness Soft  
 Fabric No  
 Magnetic No

Item # **SQ-0307**



**Gray Squeegee with Ruler**

Dimensions 3" x 6"  
 Material Plastic  
 Color Gray  
 Hardness Medium  
 Fabric Suede  
 Magnetic No

Item # **SQ-0401**



**4" Black Magnetic Squeegee**

Dimensions 4" x 3"  
 Material Plastic  
 Color Black  
 Hardness Hard  
 Fabric No  
 Magnetic Yes

Item # **SQ-0402**



**4" Black Magnetic Squeegee**

Dimensions 4" x 3"  
 Material Plastic  
 Color Black  
 Hardness Hard  
 Fabric Suede  
 Magnetic Yes

Item # **SQ-0403**



**Gold Trapezoid Magnetic Squeegee**

Dimensions 3" x 2 1/2"  
 Material Plastic  
 Color Gold  
 Hardness Medium  
 Fabric No  
 Magnetic Yes

Item # **SQ-0404**



**Gold Trapezoid Magnetic Squeegee**

Dimensions 3" x 2 1/2"  
 Material Plastic  
 Color Gold  
 Hardness Medium  
 Fabric Yes  
 Magnetic Yes

Item # **SQ-0405**



**Gold Trapezoid Magnetic Squeegee**

Dimensions 3" x 2 1/2"  
 Material Plastic  
 Color Gold  
 Hardness Medium  
 Fabric Yes  
 Magnetic Yes

## SPECIALTY, CORNER & TUCKING SQUEEGEES

### Specialty Squeegees

Item # **SQ-0204**



**Mini Gray Squeegee**

Dimensions 2 1/2" x 1"  
Material Plastic  
Color Gray  
Hardness Medium  
Magnetic No

Item # **SQ-0205**



**Gray 90° Squeegee**

Dimensions 2 1/2" x 1"  
Material Plastic  
Color Gray  
Hardness Medium  
Magnetic No

Item # **SQ-0206**



**Gray 135° Squeegee**

Dimensions 2 1/2" x 1"  
Material Plastic  
Color Gray  
Hardness Medium  
Magnetic No



Item # **SQ-0105**



**Blue Trapezoid Squeegee**

Dimensions 5" x 4"  
Material Plastic  
Color Blue  
Hardness Medium  
Fabric No  
Magnetic No

Item # **SQ-0216**



**Soft Blue Micro Mini Squeegee Tucking Tool**

Dimensions 6 1/2" x 1"  
Material Plastic  
Color Blue  
Hardness Soft  
Fabric No  
Magnetic No

Item # **SQ-0217**



**Medium Red Micro Mini Squeegee Tucking Tool**

Dimensions 2 1/2" x 1"  
Material Plastic  
Color Red  
Hardness Medium  
Fabric No  
Magnetic No

Item # **SQ-0218**



**Hard Black Micro Mini Squeegee Tucking Tool**

Dimensions 2 1/2" x 1"  
Material Plastic  
Color Black  
Hardness Hard  
Fabric No  
Magnetic No

Item # 3" **SQ-0304**  
6" **SQ-0305**  
12" **SQ-0306**



**White Hard Squeegee, with Black Soft Rubber Edge**

Dimensions 3", 6", 12"  
Material Plastic  
Color White  
Hardness Hard & Soft  
Fabric No  
Magnetic No

### Corner & Tucking Squeegees

Item # **SQ-0208**



**1" Orange Mini Magnetic Corner Wrap Squeegee**

Dimensions 6 1/2" x 1"  
Material Plastic  
Color Orange  
Hardness Medium  
Fabric No  
Magnetic No

Item # **SQ-0209**



**1" Red Mini Magnetic Wrap Tucking Squeegee**

Dimensions 6 1/2" x 1"  
Material Plastic  
Color Orange  
Hardness Medium  
Fabric No  
Magnetic Yes

Item # **SQ-0211**



**1" Turquoise Mini Magnetic Wrap Circular Tucking Squeegee**

Dimensions 6 1/2" x 1"  
Material Plastic  
Color Orange  
Hardness Medium  
Fabric No  
Magnetic Yes

Item # **SQ-0213**



**1" Blue Mini Magnetic Wrap Tucking Squeegee**

Dimensions 6 1/2" x 1"  
Material Plastic  
Color Orange  
Hardness Medium  
Fabric No  
Magnetic Yes

Item # **SQ-0214**



**1" Yellow Mini Magnetic Wrap Tucking Squeegee**

Dimensions 6 1/2" x 1"  
Material Plastic  
Color Orange  
Hardness Medium  
Fabric No  
Magnetic Yes

## SQUEEGEES, REMOVAL TOOLS & KITS

### Wrap Puller Squeegees

Item # **SQ-0219**



**3" Orange Corner Wrap Squeegee**

Dimensions 3" x 1"  
 Material Plastic  
 Color Orange  
 Hardness Medium  
 Magnetic No

Item # **SQ-0210**



**1" Black Micro Magnetic Corner Wrap Squeegee**

Dimensions 6 1/2" x 1"  
 Material Plastic  
 Color Black  
 Hardness Hard  
 Magnetic Yes

Item # **SQ-0212**



**1" Gray Mini Magnetic Wrap Puller**

Dimensions 6 1/2" x 1/4"  
 Material Plastic  
 Color Gray  
 Hardness Hard  
 Magnetic Yes

### Specialty Removal Tools

Item # **SQ-0903**



**Yellow Squeegee**

Dimensions 12" x 6"  
 Material Plastic  
 Color Yellow  
 Hardness Hard  
 Magnetic No

Item # **SQ-0901**



**Lil' Chizler Removal Tool**

Dimensions 3" x 2 1/4"  
 Material Plastic  
 Color Pink  
 Hardness Hard  
 Magnetic No

### Specialty Removal Tools

Item # **SQ-0902**



**Multi Side Length Blue Chisel**

Dimensions 7" x 3 1/2"  
 Material Plastic  
 Color Blue  
 Hardness Hard  
 Fabric No  
 Magnetic No

Item # **SQ-0701**



**Gator Blade, with Grip Grooves and Molded Corners**

Dimensions 4 1/2" x 4"  
 Material Plastic  
 Color Yellow  
 Hardness Hard  
 Fabric No  
 Magnetic No

Item # **SQ-0702**



**Black High Heat Resistant Squeegee Resist up to 660°**

Dimensions 4 1/2" x 10"  
 Material Plastic  
 Color Black  
 Hardness Hard  
 Fabric No  
 Magnetic No

### Squeegee Kits

Item # **SQ-0202**



**3 in 1 Small Magnetic Squeegee Kit with Felt**

Dimensions 4" x 1 1/3"  
 Material Plastic  
 Color Multi  
 Hardness S/M/H  
 Fabric Yes  
 Magnetic No

Item # **SQ-0203**



**3 in 1 Small Magnetic Squeegee Kit with Felt**

Dimensions 6 1/2" x 1"  
 Material Plastic  
 Color Multi  
 Hardness S/M/H  
 Fabric Yes  
 Magnetic No

Item # **SQ-0207**



**7 in 1 Micro Mini Magnetic Squeegees**

Dimensions 6 1/2" x 1"  
 Material Plastic  
 Color Multi  
 Hardness Medium  
 Fabric No  
 Magnetic Yes

Item # **SQ-0201**



**3 in 1 Wrap Sticks with Magnets 100° / 83° / 72°**

Dimensions 6 1/2" x 1"  
 Material Plastic  
 Color Multi  
 Hardness S/M/H  
 Fabric No  
 Magnetic Yes

Item # **SQ-0200**



**18 in 1 Multi Purpose Squeegee Set**

Dimensions 8" x 4"  
 Material Plastic  
 Color Multi  
 Hardness S/M/H  
 Fabric Yes  
 Magnetic Yes

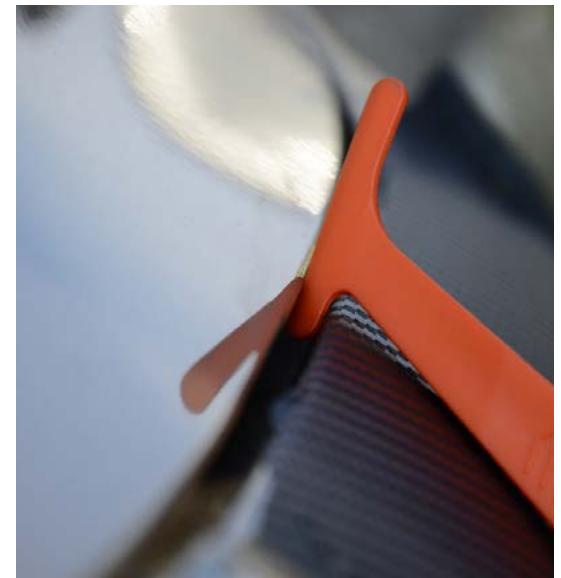

# TINT, VINYL ROLLERS & EFFICIENCY ACCESSORIES

## Tint Tools

Item # **SQ-0505**



**White Silicone Squeegee with Handle**

|            |         |
|------------|---------|
| Dimensions | 11 5/8" |
| Material   | Plastic |
| Color      | White   |
| Hardness   | Soft    |
| Magnetic   | Yes     |

Item # 10" **SQ-0502**  
14" **SQ-0503**  
18" **SQ-0504**



**Stainless Steel Water Squeegees**

|          |                 |
|----------|-----------------|
| Length   | 10", 14", 18"   |
| Material | Stainless Steel |
| Color    | Blue            |
| Hardness | Soft            |
| Spare    | SQ-0501         |

Item # **SQ-0501**



**Water Squeegee Pro Replacement Rubber**

|            |              |
|------------|--------------|
| Dimensions | 6 1/2" x 41" |
| Material   | Plastic      |
| Color      | Blue         |
| Hardness   | Medium       |

Item # **SQ-0601**



**Blue Squeegee with Short Ergonomic Handle**

|            |         |
|------------|---------|
| Dimensions | 6" x 5" |
| Material   | Plastic |
| Color      | Blue    |
| Hardness   | Medium  |

Item # **SQ-0602**



**Blue Squeegee with Palm Ergonomic Handle**

|            |            |
|------------|------------|
| Dimensions | 5" x 5/16" |
| Material   | Plastic    |
| Color      | Blue       |
| Hardness   | Medium     |

Item # 2" **SQ-0605**  
4" **SQ-0606**



**Turbo Water Blades with Grips**

|          |        |
|----------|--------|
| Length   | 2", 4" |
| Material | Rubber |
| Color    | Yellow |
| Hardness | Soft   |

Item # 4" **SQ-0603**  
2" **SQ-0604**



**Replacement Turbo Water Blades**

|          |        |
|----------|--------|
| Length   | 4", 2" |
| Material | Rubber |
| Color    | Yellow |
| Hardness | Soft   |

Item # **AC-0103**



**Green "DO NOT ROLL DOWN" Sticker for Window Switches**

|           |               |
|-----------|---------------|
| Material  | Paper Sticker |
| Color     | Green         |
| Removable | Yes           |

Item # **AC-0109**



**30 oz Gray Commercial-Grade Spray Bottle**

|          |         |
|----------|---------|
| Weight   | 30 oz   |
| Material | Plastic |
| Color    | Gray    |

Item # **AC-0110**



**24 oz Clear Commercial-Grade Spray Bottle**

|          |         |
|----------|---------|
| Weight   | 24 oz   |
| Material | Plastic |
| Color    | Clear   |

## Vinyl Rollers

Item # 4" **VR-0103**  
6" **VR-0104**  
8" **VR-0105**  
12" **VR-0106**



**Blue Application Rollers**

|          |                 |
|----------|-----------------|
| Material | Plastic         |
| Width    | 4", 6", 8", 12" |
| Color    | Blue            |

Item # 4" **VR-0107**  
6" **VR-0108**  
8" **VR-0109**  
12" **VR-0110**



**Gray Application Rollers with 3 Way Adjustable Handles**

|          |                 |
|----------|-----------------|
| Material | Metal           |
| Width    | 4", 6", 8", 12" |
| Color    | Gray            |

Item # **VR-0111**



**2" Roller Vehicle Channel Applicator Wheel**

|          |         |
|----------|---------|
| Material | Plastic |
| Width    | 2"      |
| Color    | Gray    |

## Efficiency Accessories

Item # **AC-0111**



**Wrist Band with Magnet**

|          |        |
|----------|--------|
| Length   | 2 1/2" |
| Width    | 2"     |
| Material | Fabric |
| Color    | Black  |

Item # **AC-0112**



**Magnetic Tool Holding Wrist Strap**

|          |        |
|----------|--------|
| Length   | 13"    |
| Width    | 2 1/2" |
| Material | Fabric |
| Color    | Black  |



# WRAP GLOVES, MAGNETS & TOOL POUCHES

## Wrap Gloves

Item # **WG-0101**



**Professional Anti-Static Vinyl Wrapping Glove**

|          |       |
|----------|-------|
| Size     | Large |
| Material | Cloth |
| Color    | Gray  |

Item # **WG-0102**



**The Wrap Glove Ghost White for PPF**

|          |          |
|----------|----------|
| Size     | Fits All |
| Material | Cloth    |
| Color    | White    |

Item # **WG**



**Professional Anti-Heat Vinyl Wrapping Glove**

|         |         |
|---------|---------|
| Small   | WG-0103 |
| Medium  | WG-0104 |
| Large   | WG-0105 |
| X-Large | WG-0106 |

Item # **WG-0201**



**Professional Anti-Heat Vinyl Wrapping Glove**

|          |           |
|----------|-----------|
| Size     | Large     |
| Material | Not Cloth |
| Color    | Gray      |

Item # **WG-0301**



**The Squeegee Glove Ghost**

|          |       |
|----------|-------|
| Length   | 3"    |
| Height   | 4"    |
| Material | Cloth |
| Color    | White |

## Magnets

Item # **WM-0101**



**Rectangular Magnet**

|          |        |
|----------|--------|
| Length   | 3 3/4" |
| Width    | 1 3/4" |
| Color    | Red    |
| Fabric   | Felt   |
| Magnetic | No     |

Item # **WM-0102**



**Circular Magnet**

|          |        |
|----------|--------|
| Diameter | 3 1/2" |
| Handle   | Yes    |
| Color    | Black  |
| Fabric   | No     |
| Magnetic | Yes    |

Item # **WM-0103**



**Circular Magnet**

|          |        |
|----------|--------|
| Diameter | 1 3/4" |
| Handle   | Yes    |
| Color    | Black  |
| Fabric   | No     |
| Magnetic | Yes    |

Item # **WM-0104**



**Squared Patch**

|          |          |
|----------|----------|
| Length   | 1 1/2"   |
| Width    | 1 1/2"   |
| Color    | Red      |
| Magnetic | Yes      |
| Shape    | Circular |
| Material | Metal    |

Item # **AC-0104**



**10' Soft Magnetic Measuring Tape**

|          |        |
|----------|--------|
| Length   | 10'    |
| Width    | 1/2"   |
| Material | Vinyl  |
| Color    | Yellow |
| Magnetic | Yes    |

## Knee Pads

Item # **SP-0101**



**Sponge Filled Knee Pads**

|          |         |
|----------|---------|
| Width    | 7"      |
| Height   | 8"      |
| Size     | Large   |
| Material | Plastic |
| Color    | Black   |

## Tool Pouches

Item # **TB-0101**



**6 Compartment Belt Wrap Pouch**

|              |         |
|--------------|---------|
| Width        | 5 1/2"  |
| Height       | 10 1/4" |
| Material     | Fabric  |
| Color        | Black   |
| Compartment  | 6       |
| Waist Buckle | No      |

Item # **TB-0102**



**12 Compartment Multi-Purpose Waist Wrap Pouch**

|              |        |
|--------------|--------|
| Width        | 7"     |
| Height       | 9 1/4" |
| Material     | Fabric |
| Color        | Black  |
| Compartment  | 12     |
| Waist Buckle | No     |

Item # **TB-0103**



**8 Compartment Multi-Purpose Waist Wrap Pouch**

|              |         |
|--------------|---------|
| Width        | 23 1/3" |
| Height       | 10 1/2" |
| Material     | Fabric  |
| Color        | Black   |
| Compartment  | 8       |
| Waist Buckle | Yes     |

Item # **TB-0104**



**5" Magnetic Tool Pouch**

|          |        |
|----------|--------|
| Width    | 4 1/4" |
| Height   | 5 1/2" |
| Material | Fabric |
| Color    | Black  |

## SCRAPERS & SPARE BLADES

### Metal Scrapers

Item # **SP-0101**



**Triumph Scraper with Ergonomic Handle, and Blade Cover**

Dimensions 8" x 4"  
Material Aluminum  
Color Gray  
Blade type 4" Scraper  
Edges Single

Item # **SP-0104**



**Retractable Stainless Steel Razor Blade Scraper**

Dimensions 4" x 1 3/4"  
Material Carbon Steel  
Color Gray  
Blade type Safety Blade  
Edges Single

Item # **SP-0105**



**Plastic Scraper with Ergonomic Handle, and Blade Cover**

Dimensions 7" x 6"  
Material Plastic  
Color Black  
Blade type 6" Scraper  
Edges Double

Item # **SP-0106**



**Mini 1 1/2" Razor Blade Scraper**

Dimensions 2" x 2"  
Material Plastic  
Color Red  
Blade type Safety Blade  
Edges Double

Item # **SP-0107**



**1 1/2" Razor Blade Scraper**

Dimensions 4 1/2" x 2"  
Material Plastic  
Color Red  
Blade type Safety Blade  
Edges Double

### Plastic Scrapers

Item # **SP-0108**



**Scraper with Ergonomic Handle**

Dimensions 7 1/2" x 6"  
Material Plastic  
Color Black  
Blade type 6" Scraper  
Edges Double

Item # **SP-0103**



**Plastic Razor Blade Scraper**

Dimensions 4" x 1 1/2"  
Material Plastic  
Color Blue  
Blade type Safety Blade  
Edges Single

Item # **SP-0109**



**Long Handle Scraper with EVA Foam**

Dimensions 6" x 1 1/2"  
Material Plastic  
Color Red  
Blade type Safety Blade  
Edges Double

Item # **SP-0110**



**Scraping Blade Sharpener**

Width 2"  
Height 3"  
Material Carbon Steel  
Color Red

### Emblem Removal

Item # **RT-0101BL**



**Double Grip Cable Emblem Removal Tool**

|        |                  |
|--------|------------------|
| Silver | <b>RT-0101</b>   |
| Blue   | <b>RT-0101BL</b> |
| Red    | <b>RT-0101RD</b> |
| Black  | <b>RT-0101BM</b> |

### Scraper Spare Blades

Item # **SP-0102**



**Replacement Scraper Blades Blade with Carrying Case**

Dimensions 1" x 4"  
Material Steel  
Color Gray  
Blade type 4" Scraper  
Edges Single  
Qty 10

Item # **SP-0201**



**Double Edge Plastic Razor Blade Scraper**

Dimensions 1 1/2" x 1"  
Material Plastic  
Color Red  
Blade type Safety Blade  
Edges Double  
Qty 100

Item # **SP-0202**



**Carbon Steel Razor Blade Scraper**

Dimensions 1 1/2" x 1"  
Material Carbon Steel  
Color Gray  
Blade type Safety Blade  
Edges Single  
Qty 100

Item # **SP-0203**



**Double Edge Plastic Razor Blade Scraper**

Dimensions 1 1/2"  
Material Stainless Steel  
Color Gray  
Blade type Safety Blade  
Edges Double  
Qty 100

Item # **SP-0204**



**Heavy Duty Double Sided Stainless Steel Blade**

Dimensions 1" x 6"  
Material Carbon Steel  
Color Gray  
Blade type Safety Blade  
Edges Single  
Qty 25

## TOOLS, ELECTRONICS & REPLACEMENTS

### Removal Tools

Item # **RT-0201**



**4 pcs Yellow Multi Variety Tool Set**

Material Plastic  
Color Yellow

Item # **RT-0202**



**12 pcs Orange Mutli Variety Tool Set**

Material Plastic  
Color Orange

### Tweezers

Item # **AC-0106**



**Fine Tip Curved Tweezers**

Dimensions 4 3/4" x 1/4"  
Material Metal  
Color Black

Item # **AC-0107**



**Flat Round Tip Tweezers**

Dimensions 4 3/4" x 1/4"  
Material Metal  
Color Black

Item # **AC-0108**



**Super Fine Tip Tweezers**

Dimensions 4 3/4" x 1/4"  
Material Metal  
Color Black

### Vinyl Displays

Item # **AC-0101**



**Model Car Hood Vinyl Display**

Dimensions 12" x 10"  
Material Plastic  
Color Black

Item # **AC-0102**



**Model Car Vinyl Display**

Dimensions 8" x 4"  
Material Plastic  
Color Black

### Heat Guns

Item # **TT-0101**



**1800 Watt Heat Gun with Digital Temperature Display**

Material 4 1/2"  
Color Gray

Item # **TT-0102**



**Heat Gun Holder**

Diameter 3 1/8"  
Material Metal  
Color Red  
Magnet Yes

### Replacements

Item # **SQ-0801**



**Roll of Black Soft Fabric Felt**

Dimensions 1 1/2" x 16'  
Material Fabric Felt  
Color Black  
Hardness Soft

Item # **SQ-0802**



**Replacement Felt**

Dimensions 4" x 1 1/2"  
Material Fabric Felt  
Color White  
Hardness Soft  
Fabric Wool

Item # **SQ-0803**



**Replacement Felt**

Dimensions 4" x 1 1/2"  
Material Fabric Felt  
Color Red  
Fabric Yes

Item # **SQ-0804**



**Roll of Ultra Slim Red Soft Fabric Felt**

Dimensions 1 1/2" x 16'  
Material Fabric Felt  
Color Red  
Fabric Yes

### Sheet Clips

Item # **WS**



**Vinyl Wrap Sheet Clip Storage Tool**

3" **WS-0101**  
4" **WS-0102**  
Material Plastic  
Color Yellow

### Air Release

Item # **CT-0405**



**Avery Silver Metal Air Release Pen**

Length 5-1/2"  
Material Metal



**Plotter Paper Direct**

Your Wholesale Paper Source

Manufactured in our Facilities  
Made in USA





# Paper Materials

## **PLOTTER PAPER ROLLS**

|               |    |
|---------------|----|
| 20 lb. Bond   | 94 |
| 24 lb. Bond   | 94 |
| 36 lb. Bond   | 94 |
| 46 lb. Bond   | 94 |
| 20 lb. Vellum | 94 |

## **ENGINEERING BOND PAPER ROLLS**

|                    |    |
|--------------------|----|
| 20 lb. Xerographic | 94 |
|--------------------|----|

## **COLORED BOND PAPER ROLLS**

|               |    |
|---------------|----|
| 20 lb. Blue   | 94 |
| 20 lb. Green  | 94 |
| 20 lb. Yellow | 94 |

## **MYLAR & VELLUM FILM ROLLS**

|                     |    |
|---------------------|----|
| 4 mil. Single Matte | 95 |
| 4 mil. Double Matte | 95 |
| 20 lb. Vellum       | 95 |
| 4 mil Monochrome    | 95 |
| 4 mil. Xerographic  | 95 |

## **PLOTTER PAPER SHEETS**

|                        |    |
|------------------------|----|
| 18 lb. Bond            | 95 |
| 20 lb. Bond            | 95 |
| 24 lb. Bond            | 95 |
| 20 lb. Vellum          | 95 |
| 18 lb. Translucent     | 95 |
| 4 mil. Translucent     | 95 |
| 4 mil. Bond            | 95 |
| 4 mil. Mylar           | 95 |
| 20 lb. Xerographic     | 95 |
| 20 lb. Mylar for Color | 95 |
| 20 lb. Monochrome      | 95 |

Paper Roll & Sheets



**We're a manufacturer, not just a reseller.**  
 Custom and more sizes available upon request, next day turnaround.



**Plotter Paper Rolls**

| Key Features |      |              |           | Available Sizes |            |            |            |            |            |            |            |            |            |            |            |            |            |            |            | Item #     |            |            |            |            |            |            |            |            |            |            |            |   |                  |
|--------------|------|--------------|-----------|-----------------|------------|------------|------------|------------|------------|------------|------------|------------|------------|------------|------------|------------|------------|------------|------------|------------|------------|------------|------------|------------|------------|------------|------------|------------|------------|------------|------------|---|------------------|
| Weight       | Type | Finish       | Core Size | 24" x 100'      | 30" x 100' | 36" x 100' | 42" x 100' | 44" x 100' | 50" x 100' | 54" x 100' | 11" x 150' | 17" x 150' | 18" x 150' | 22" x 150' | 24" x 150' | 30" x 150' | 34" x 150' | 36" x 150' | 42" x 150' | 44" x 150' | 60" x 150' | 24" x 200' | 60" x 200' | 18" x 300' | 24" x 300' | 30" x 300' | 34" x 300' | 36" x 300' | 42" x 300' | 50" x 300' | 60" x 300' |   |                  |
| 20 lb.       | Bond | Opaque       | 2"        |                 |            |            |            |            |            |            | ✓          | ✓          | ✓          | ✓          | ✓          | ✓          | ✓          | ✓          | ✓          | ✓          | ✓          |            |            |            | ✓          | ✓          | ✓          | ✓          | ✓          | ✓          | ✓          | ✓ | Plotter Paper    |
| 24 lb.       | Bond | Matte        | 2"        |                 |            |            |            |            |            |            | ✓          |            |            |            | ✓          | ✓          |            | ✓          | ✓          | ✓          |            |            |            |            |            | ✓          | ✓          | ✓          | ✓          | ✓          | ✓          | ✓ | Plotter Paper    |
| 24 lb.       | Bond | Coated Matte | 2"        |                 |            |            |            |            |            |            |            |            |            |            | ✓          | ✓          |            | ✓          | ✓          | ✓          |            |            |            |            |            | ✓          | ✓          |            | ✓          | ✓          |            |   | Coated Bond      |
| 36 lb.       | Bond | Coated Matte | 2"        | ✓               | ✓          | ✓          | ✓          | ✓          | ✓          | ✓          |            |            |            |            |            |            |            |            |            |            |            |            | ✓          |            |            | ✓          |            |            |            |            | ✓          |   | Coated Bond      |
| 46 lb.       | Bond | Coated Matte | 2"        | ✓               | ✓          | ✓          | ✓          | ✓          | ✓          | ✓          |            |            |            |            |            |            |            |            |            |            |            |            | ✓          |            |            |            |            |            |            |            | ✓          |   | Coated Bond      |
| 18 lb.       | Bond | Translucent  | 2"        |                 |            |            |            |            |            |            |            |            |            |            | ✓          | ✓          |            | ✓          | ✓          |            |            |            |            |            |            | ✓          | ✓          | ✓          |            |            |            |   | Translucent Bond |

**Engineering Bond Paper Rolls**

| Key Features |             |        |       |           | Available Sizes |            |            |            |            |            |            |            |            |            |            |            | Item #     |            |   |             |
|--------------|-------------|--------|-------|-----------|-----------------|------------|------------|------------|------------|------------|------------|------------|------------|------------|------------|------------|------------|------------|---|-------------|
| Weight       | Type        | Finish | Color | Core Size | 18" x 500'      | 22" x 500' | 24" x 500' | 30" x 500' | 34" x 500' | 36" x 500' | 42" x 500' | 18" x 650' | 22" x 650' | 24" x 650' | 30" x 650' | 34" x 650' | 36" x 650' | 42" x 650' |   |             |
| 20 lb.       | Xerographic | Matte  | White | 3"        | ✓               | ✓          | ✓          | ✓          | ✓          | ✓          | ✓          | ✓          | ✓          | ✓          | ✓          | ✓          | ✓          | ✓          | ✓ | Engineering |

**Colored Bond Rolls**

| Key Features |      |        |        |           | Available Sizes |            |            |            |            |            |            |            |            | Item #     |               |
|--------------|------|--------|--------|-----------|-----------------|------------|------------|------------|------------|------------|------------|------------|------------|------------|---------------|
| Weight       | Type | Finish | Color  | Core Size | 18" x 150'      | 22" x 150' | 24" x 150' | 30" x 150' | 34" x 150' | 18" x 300' | 22" x 300' | 24" x 300' | 30" x 300' | 34" x 300' |               |
| 20 lb.       | Bond | Opaque | Blue   | 3"        | ✓               | ✓          | ✓          | ✓          | ✓          | ✓          | ✓          | ✓          | ✓          | ✓          | Blue Tinted   |
| 20 lb.       | Bond | Opaque | Green  | 3"        | ✓               | ✓          | ✓          | ✓          | ✓          | ✓          | ✓          | ✓          | ✓          | ✓          | Green Tinted  |
| 20 lb.       | Bond | Opaque | Yellow | 3"        | ✓               | ✓          | ✓          | ✓          | ✓          | ✓          | ✓          | ✓          | ✓          | ✓          | Yellow Tinted |



## Paper Roll & Sheets

### Mylar and Films

| Key Features |               |              |             |           | Available Sizes |            |            |            |            |            |            |            | Item #     |            |                                    |
|--------------|---------------|--------------|-------------|-----------|-----------------|------------|------------|------------|------------|------------|------------|------------|------------|------------|------------------------------------|
| Thickness    | Type          | Finish       | Color       | Core Size | 24" X 120'      | 30" X 120' | 36" X 120' | 42" X 120' | 11" x 150' | 18" x 150' | 24" x 150' | 30" x 150' | 36" x 150' | 42" x 150' |                                    |
| 4 mil.       | Heat-tolerant | Single Matte | White       | 3"        |                 |            |            |            |            | ✓          | ✓          | ✓          | ✓          |            | <b>7228 Single Matte</b>           |
| 4 mil.       | Heat-tolerant | Double Matte | White       | 3"        |                 |            |            |            |            |            |            | ✓          | ✓          |            | <b>7163 Double Matte for color</b> |
| 20 lb.       | Vellum        | Matte        | Translucent | 2"        |                 |            |            |            | ✓          |            | ✓          | ✓          | ✓          | ✓          | <b>Inkjet Vellum</b>               |
| 4 mil        | Monochrome    | Matte        | Translucent | 2"        | ✓               | ✓          | ✓          | ✓          |            |            |            |            |            |            | <b>4MDIK2</b>                      |
| 4 mil        | Monochrome    | Matte        | Translucent | 3"        | ✓               | ✓          | ✓          | ✓          |            |            |            |            |            |            | <b>4MDIK3</b>                      |
| 4 mil        | Xerographic   | Matte        | Translucent | 3"        |                 |            |            |            |            |            | ✓          | ✓          | ✓          |            | <b>4MDX</b>                        |

### Plotter Paper Sheets

| Key Features |                 |              |       | Available Sizes |           |           |           |           |           |           |           |           | Item #                  |
|--------------|-----------------|--------------|-------|-----------------|-----------|-----------|-----------|-----------|-----------|-----------|-----------|-----------|-------------------------|
| Weight       | Type            | Finish       | Color | 8½" x 11"       | 11" x 17" | 12" x 18" | 17" x 22" | 18" x 24" | 22" x 34" | 24" x 36" | 30" x 42" | 36" x 48" |                         |
| 20 lb.       | Bond            | Opaque       | White |                 | ✓         |           | ✓         | ✓         | ✓         | ✓         | ✓         | ✓         | <b>Plotter Paper</b>    |
| 24 lb.       | Plotter Paper   | Matte        | White | ✓               | ✓         | ✓         | ✓         | ✓         | ✓         | ✓         | ✓         | ✓         | <b>Coated Bond</b>      |
| 18 lb.       | Translucent     | Matte        | White |                 | ✓         |           | ✓         | ✓         |           | ✓         |           |           | <b>Translucent Bond</b> |
| 20 lb.       | Vellum          | Matte        | White | ✓               | ✓         | ✓         | ✓         | ✓         | ✓         | ✓         |           |           | <b>Inkjet Vellum</b>    |
| 4 mil.       | Bond            | Matte        | White |                 | ✓         |           | ✓         | ✓         |           | ✓         |           |           | <b>6500 - Mylar</b>     |
| 4 mil.       | Bond            | Matte        | White |                 | ✓         |           | ✓         | ✓         |           | ✓         |           |           | <b>6550 - Mylar</b>     |
| 20 lb.       | Monochrome      | Double Matte | White |                 | ✓         |           | ✓         | ✓         |           | ✓         |           |           | <b>Mylar</b>            |
| 20 lb.       | Mylar for Color | Double Matte | White | ✓               |           | ✓         |           |           |           |           |           |           | <b>Mylar</b>            |
| 4 mil.       | Heat-tolerant   | Double Matte | White |                 | ✓         |           | ✓         | ✓         |           | ✓         |           |           | <b>7215 - Mylar</b>     |
| 4 mil.       | Heat-tolerant   | Double Matte | White |                 | ✓         |           | ✓         | ✓         |           | ✓         |           |           | <b>7150 - Mylar</b>     |



CAFE

**MENU**



5054 MAIN STREET YOUR CITY  
DELIVERY: 022 4802021  
OPEN MON-FRI: 11 AM-10:00PM SAT-SUN: 8 AM-10:00PM





# Frames & Displays

## A-FRAMES

|   |    |
|---|----|
| A-Frame Slide-in/Bolt-in Sign Panel Frame | 98 |
|---|----|

## REAL ESTATE SIGNS

|   |    |
|---|----|
| Round Rod Sign Frame                            | 98 |
| Single Rider Slide-in/Bolt-in Real Estate Frame | 98 |
| Double Rider Slide-in Bolt-in Real Estate Frame | 99 |
| Frame Clips                                     | 99 |

## SIGN STAKES

|                                |     |
|--------------------------------|-----|
| Single Pole T Style Sign Stake | 100 |
| Single Pole Sign Stake         | 100 |
| Economy Stake                  | 100 |
| Heavy Stake                    | 100 |
| Super Heavy Duty Stake         | 100 |
| Half Stake                     | 100 |

A-Frames & Real Estate Signs



**High-quality sign stands.  
Stays securely in place. No  
maintenance, use outdoors.**



Item # AF24-18



**24" x 18"  
A-Frame Slide-in/Bolt-in  
Sign Panel Frame**

|                 |                    |
|-----------------|--------------------|
| Width           | 24"                |
| Height          | 18"                |
| Signs Per Frame | 2                  |
| Color           | Black, White, Gray |
| Thickness       | 1/8"               |
| Material        | Powder Coated Iron |

Item # AF24-36



**24" x 36"  
A-Frame Slide-in/Bolt-in  
Sign Panel Frame**

|                 |                    |
|-----------------|--------------------|
| Width           | 24"                |
| Height          | 36"                |
| Signs Per Frame | 2                  |
| Color           | Black, White       |
| Thickness       | 1/8"               |
| Material        | Powder Coated Iron |

Item # RES24-18

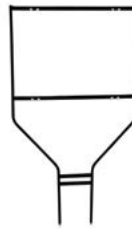

**Round Rod  
Sign Frame**

|           |                    |
|-----------|--------------------|
| Width     | 24"                |
| Height    | 18"                |
| Material  | Iron               |
| Finish    | Powder Coated      |
| Color     | Black, White, Gray |
| Thickness | 1/8"               |

Item # RES18-12

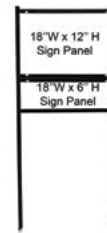

**Single Rider Slide-in  
Bolt-in Real Estate Sign  
Panel Frame**

|           |                    |
|-----------|--------------------|
| Width     | 18"                |
| Height    | 12"                |
| Material  | Iron               |
| Finish    | Powder Coated      |
| Color     | Black, White, Gray |
| Thickness | 1/8"               |

Item # RES18-24

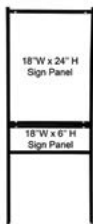

**Single Rider Slide-in  
Bolt-in Real Estate Sign  
Panel Frame**

|            |                    |
|------------|--------------------|
| Dimensions | 18" x 24"          |
| Material   | Iron               |
| Finish     | Powder Coated      |
| Color      | Black, White, Gray |
| Thickness  | 1/8"               |

Item # RES24-18

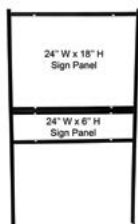

**Single Rider Slide-in  
Bolt-in Real Estate Sign  
Panel Frame**

|           |                    |
|-----------|--------------------|
| Width     | 24" x 18"          |
| Material  | Iron               |
| Finish    | Powder Coated      |
| Color     | Black, White, Gray |
| Thickness | 1/8"               |

Item # RES24-24

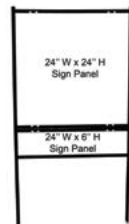

**Single Rider Slide-in  
Bolt-in Real Estate Sign  
Panel Frame**

|           |                    |
|-----------|--------------------|
| Width     | 24" x 24"          |
| Material  | Iron               |
| Finish    | Powder Coated      |
| Color     | Black, White, Gray |
| Thickness | 1/8"               |

Item # RES24-30



**Single Rider Slide-in  
Bolt-in Real Estate Sign  
Panel Frame**

|           |                    |
|-----------|--------------------|
| Width     | 24" x 30"          |
| Material  | Iron               |
| Finish    | Powder Coated      |
| Color     | Black, White, Gray |
| Thickness | 1/8"               |

Real Estate Signs

Item # **RES30-18**

**Single Rider Slide-in Bolt-in Real Estate Sign Panel Frame**

|           |                    |
|-----------|--------------------|
| Width     | 30"                |
| Height    | 18"                |
| Material  | Iron               |
| Finish    | Powder Coated      |
| Color     | Black, White, Gray |
| Thickness | 1/8"               |

Item # **RES30-24**

**Single Rider Slide-in Bolt-in Real Estate Sign Panel Frame**

|           |                    |
|-----------|--------------------|
| Width     | 30"                |
| Height    | 24"                |
| Material  | Iron               |
| Finish    | Powder Coated      |
| Color     | Black, White, Gray |
| Thickness | 1/8"               |

Item # **RES36-24**

**Single Rider Slide-in Bolt-in Real Estate Sign Panel Frame**

|           |                    |
|-----------|--------------------|
| Width     | 36"                |
| Height    | 24"                |
| Material  | Iron               |
| Finish    | Powder Coated      |
| Color     | Black, White, Gray |
| Thickness | 1/8"               |

Item # **RES18-24**

**Double Rider Slide-in Bolt-in Real Estate Sign Panel Frame**

|           |                    |
|-----------|--------------------|
| Width     | 18"                |
| Height    | 24"                |
| Material  | Iron               |
| Finish    | Powder Coated      |
| Color     | Black, White, Gray |
| Thickness | 1/8"               |

Item # **RES24-18**

**Double Rider Slide-in Bolt-in Real Estate Sign Panel Frame**

|           |                    |
|-----------|--------------------|
| Width     | 24"                |
| Height    | 18"                |
| Material  | Iron               |
| Finish    | Powder Coated      |
| Color     | Black, White, Gray |
| Thickness | 1/8"               |

Item # **RES24-24**

**Double Rider Slide-in Bolt-in Real Estate Sign Panel Frame**

|           |                    |
|-----------|--------------------|
| Width     | 24"                |
| Height    | 24"                |
| Material  | Iron               |
| Finish    | Powder Coated      |
| Color     | Black, White, Gray |
| Thickness | 1/8"               |

Item # **RES24-30**

**Double Rider Slide-in Bolt-in Real Estate Sign Panel Frame**

|           |                    |
|-----------|--------------------|
| Width     | 24"                |
| Height    | 30"                |
| Material  | Iron               |
| Finish    | Powder Coated      |
| Color     | Black, White, Gray |
| Thickness | 1/8"               |

Item # **RES30-18**

**Double Rider Slide-in Bolt-in Real Estate Sign Panel Frame**

|           |                    |
|-----------|--------------------|
| Width     | 30"                |
| Height    | 18"                |
| Material  | Iron               |
| Finish    | Powder Coated      |
| Color     | Black, White, Gray |
| Thickness | 1/8"               |



**Item # FC075-075PB**  
**Black Plastic Frame Clips**  
 3/4" x 3/4" x 1/8"  
 Accepts up to 1/8" thickness

**Item # FC075-075PW**  
**White Plastic Frame Clips**  
 3/4" x 3/4" x 1/8"  
 Accepts up to 1/8" thickness

**Item # FC075-075MB**  
**Black Iron Metal Frame Clips**  
 3/4" x 3/4" x 1/8"  
 Accepts up to 1/8" thickness

Sign Stakes



- ▶ Durable 1/4" or 9-Gauge Steel Rod
- ▶ Water Resistant
- ▶ Wind Resistant
- ▶ Quick & Easy to Assemble
- ▶ Reusable



Item # **SS-46T**

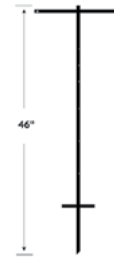

**Single Pole T Style Sign Stake 3/4"**

Thickness 1/4"  
 Height 46"  
 Finish Black Powder Coated  
 Material Steel

Item # **SS-46**



**Single Pole Sign Stake 3/4"**

Thickness 1/4"  
 Height 46"  
 Finish Black Powder Coated  
 Material Steel

Item # **ESS1030**



**Economy Stakes 10" x 30"**

Width 10"  
 Height 30"  
 Finish Zinc Plated  
 Material 9 Gauge Steel Wire

Item # **HDSS1030**

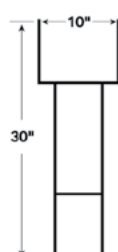

**Heavy Duty Stakes 10" x 30"**

Width 10"  
 Height 30"  
 Color Zinc Plated  
 Material 1/4" Gauge Wire

Item # **HDSS10285**



**Super Heavy Duty Stakes 10" x 28"**

Width 10"  
 Height 28"  
 Finish Black Powder Coated  
 Material 1/4" Gauge Wire

Item # **RSS1015**

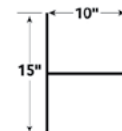

**Half Stakes 10" x 15"**

Width 10"  
 Height 15"  
 Finish Zinc Plated  
 Material 9 Gauge Steel Wire





MBS  
SIGNSUPPLY

Milano

DIGITAL  
PAPERS & FILMS

# mbs-signsupply.com

## Get All Prices Through Our Online Store!

Welcome Mbs shoppers to our WEBSITE, Enjoy it and please should you have any questions, call or email us at [contact@mbs-signsupply.com](mailto:contact@mbs-signsupply.com).



1

Log On to [mbs-signsupply.com](http://mbs-signsupply.com)  
You can select the product you are looking for by hovering over each of the categories and choosing a subcategory.

2

Search using filter selection and find the right products!

3

Use all the product tabs to find:

- Description
- Pictures
- Datasheets
- Videos

4

Our new filters make it easy to quickly find the right product. Search using filter selection and find the product for your projects needs.



# Gooseneck Barn Shades

Item # SBL14-BK-SGN15-BK



# Gooseneck Arm Shades

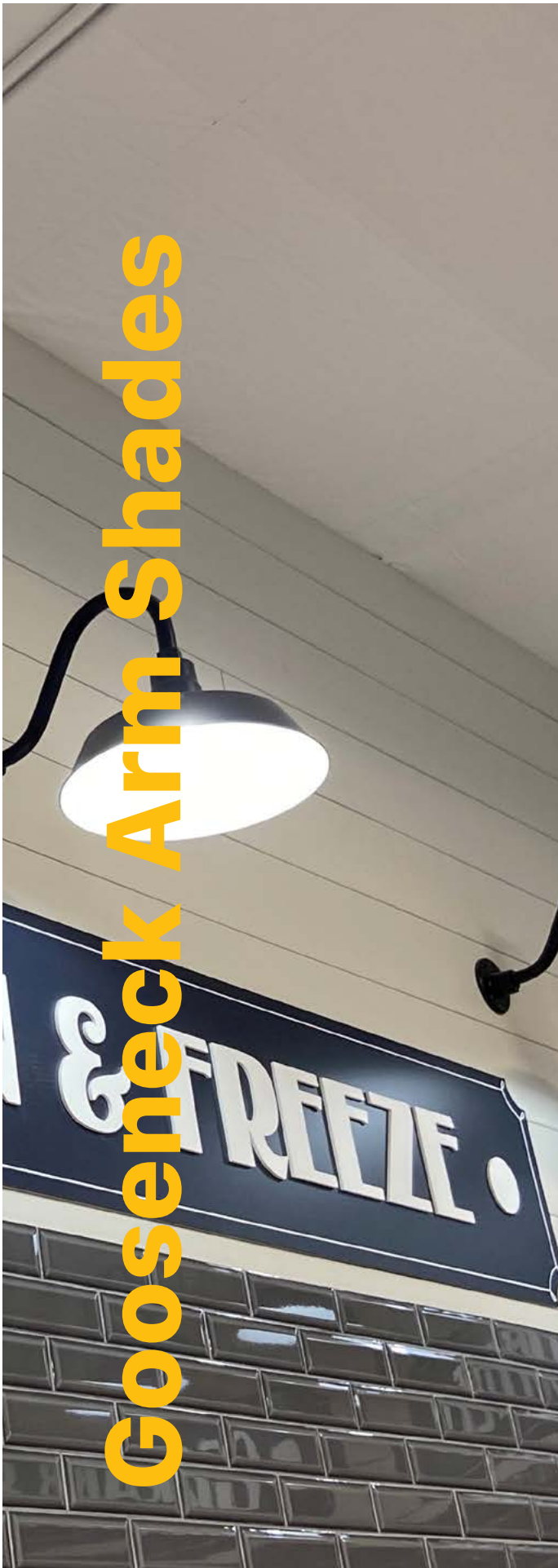

## ANGLE SHADE SIGN LIGHTS

|  |     |
|--|-----|
| Angle Shade Sign Lights with 10" Arm     | 104 |
| Angle Shade Sign Lights with 14 1/2" Arm | 104 |
| Angle Shade Sign Lights with 22" Arm     | 104 |
| Angle Shade Sign Lights with 24" Arm     | 104 |
| Straight Arm Shades 13"                  | 104 |
| Cord Hung Barn Shade with Canopy         | 104 |
| Wall Sconce Barn Lights                  | 104 |

## GOOSENECK BARN SHADES

|                                  |     |
|----------------------------------|-----|
| Barn Shade 10"                   | 105 |
| Barn Shade 14 1/2"               | 105 |
| Barn Shade 22"                   | 105 |
| Barn Shade 24"                   | 105 |
| Cord Hung Barn Shade with Canopy | 105 |
| Angle Shade 10" Ø                | 105 |
| Angle Shade 14" Ø                | 105 |
| Angle Shade 17" Ø                | 105 |

## GOOSENECK ARMS

|                 |     |
|-----------------|-----|
| 10" Arm         | 106 |
| 14 1/2" Arm     | 106 |
| 22" Arm         | 106 |
| 24" Arm         | 106 |
| Straight Arm    | 106 |
| LED Light Bulbs | 106 |



### Common Applications

- ▶ Porch & Patio Accent Lighting
- ▶ Outdoor Sign Lighting
- ▶ Awnings
- ▶ Storefront
- ▶ Restaurants
- ▶ Wall Lighting
- ▶ Commercial and Industrial
- ▶ Residential
- ▶ Barn Lighting

**Angle Shade Sign Lights** 

**Angle Shade Sign Lights Kits**

Item # **SAS**



**Angle Shade Sign Lights**

|   |   |
|---|---|
| Shade Style   | Angle Shade   |
| Shade Diameter  | 10"   |
| Arm Length  | 10"   |
| Use   | Indoor / Outdoor  |
| IP Rating      | Wet Location Rated  |
| Input Voltage  | 120V AC   |
| Finish  | Architectural Bronze, Satin Black, White, Galvanized                                |
| Material  | Cold Rolled Steel Die Casted Zinc   |
| Certification   |  |

Item # **SAS**



**Angle Shade Sign Lights**

|   |   |
|---|---|
| Shade Style   | Angle Shade   |
| Shade Diameter  | 10"   |
| Arm Length  | 14 1/2"   |
| Use   | Indoor / Outdoor  |
| IP Rating      | Wet Location Rated  |
| Input Voltage  | 120V AC   |
| Finish  | Architectural Bronze, Satin Black, White, Galvanized                                |
| Material  | Cold Rolled Steel Die Casted Zinc   |
| Certification   |  |

Item # **SAS**



**Angle Shade Sign Lights**

|  |   |
|--|---|
| Shade Style  | Angle Shade   |
| Shade Diameter   | 10"   |
| Arm Length   | 22"   |
| Use  | Indoor / Outdoor  |
| IP Rating       | Wet Location Rated  |
| Input Voltage  | 120V AC   |
| Finish   | Architectural Bronze, Satin Black, White, Galvanized                                  |
| Material   | Cold Rolled Steel Die Casted Zinc   |
| Certification  |  |

Item # **SAS**



**Angle Shade Sign Lights**

|   |   |
|---|---|
| Shade Style   | Angle Shade   |
| Shade Diameter  | 10"   |
| Arm Length  | 24"   |
| Use   | Indoor / Outdoor  |
| IP Rating      | Wet Location Rated  |
| Input Voltage  | 120V AC   |
| Finish  | Architectural Bronze, Satin Black, White, Galvanized                                  |
| Material  | Cold Rolled Steel Die Casted Zinc   |
| Certification   |  |

**Straight Arm Kits**

Item # **SAS**



**Straight Arm Shades**

|   |   |
|---|---|
| Shade Style   | Angle Shade   |
| Shade Diameter  | 10"   |
| Arm Length  | 13"   |
| Use   | Indoor / Outdoor  |
| IP Rating      | Wet Location Rated  |
| Input Voltage  | 120V AC   |
| Finish  | Architectural Bronze, Satin Black, White, Galvanized                                |
| Material  | Cold Rolled Steel Die Casted Zinc   |
| Certification   |  |

Item # **SBL**



**Straight Arm Shades**



|   |   |
|---|---|
| Shade Style   | Warehouse, Barn Shade   |
| Shade Diameter  | 17"   |
| Arm Length  | 13"   |
| Use   | Indoor / Outdoor  |
| IP Rating      | Wet Location Rated  |
| Input Voltage  | 120V AC   |
| Finish  | Architectural Bronze, Satin Black, White, Galvanized                                |
| Material  | Cold Rolled Steel Die Casted Zinc   |
| Certification   |  |

**Cord Hung Barn Shades**

Item # **SAS**





**Cord Hung Barn Shade with Canopy**

|  |   |
|--|---|
| Shade Style  | Pendant Barn Shade  |
| Shade Diameter   | 14"   |
| Shade Height   | 8"  |
| Use  | Indoor  |
| IP Rating       | Damp Location Rated   |
| Input Voltage  | 120V AC   |
| Finish   | Architectural Bronze, Satin Black, White, Galvanized                                  |
| Material   | Cold Rolled Steel   |
| Certification  |  |

Item # **SAS**



**Cord Hung Barn Shade with Canopy**

|   |   |
|---|---|
| Shade Style   | Pendant, Barn Shade   |
| Shade Diameter  | 17"   |
| Arm Length  | 9"  |
| Use   | Indoor  |
| IP Rating      | Damp Location Rated   |
| Input Voltage  | 120V AC   |
| Finish  | Architectural Bronze, Satin Black, White, Galvanized                                  |
| Material  | Cold Rolled Steel   |
| Certification   |  |



Gooseneck Barn Shades



Gooseneck Barn Shade Kits

Item # **SBL**

**Gooseneck Barn Shades**

|                |  |
|----------------|--|
| Shade Style    | Warehouse, Barn Shade                                |
| Shade Diameter | 14"  |
| Arm Length     | 10"  |
| Use            | Indoor / Outdoor                                     |
| IP Rating      | Wet Location Rated                                   |
| Input Voltage  | 120V AC  |
| Finish         | Architectural Bronze, Satin Black, White, Galvanized |
| Material       | Cold Rolled Steel Die Casted Zinc                    |
| Certification  |  |

Item # **SBL**

**Gooseneck Barn Shades**

|                |  |
|----------------|--|
| Shade Style    | Warehouse Barn Shade                                 |
| Shade Diameter | 14"  |
| Arm Length     | 14 1/2"  |
| Use            | Indoor / Outdoor                                     |
| IP Rating      | Wet Location Rated                                   |
| Input Voltage  | 120V AC  |
| Finish         | Architectural Bronze, Satin Black, White, Galvanized |
| Material       | Cold Rolled Steel Die Casted Zinc                    |
| Certification  |  |

Item # **SBL**

**Gooseneck Barn Shades**

|                |  |
|----------------|--|
| Shade Style    | Warehouse, Barn Shade                                |
| Shade Diameter | 14"  |
| Arm Length     | 22"  |
| Use            | Indoor / Outdoor                                     |
| IP Rating      | Wet Location Rated                                   |
| Input Voltage  | 120V AC  |
| Finish         | Architectural Bronze, Satin Black, White, Galvanized |
| Material       | Cold Rolled Steel Die Casted Zinc                    |
| Certification  |  |

Item # **SBL**

**Gooseneck Barn Shades**

|                |  |
|----------------|--|
| Shade Style    | Warehouse, Barn Shade                                |
| Shade Diameter | 14"  |
| Arm Length     | 24"  |
| Use            | Indoor / Outdoor                                     |
| IP Rating      | Wet Location Rated                                   |
| Input Voltage  | 120V AC  |
| Finish         | Architectural Bronze, Satin Black, White, Galvanized |
| Material       | Cold Rolled Steel Die Casted Zinc                    |
| Certification  |  |

Barn Shades

Item # **SBL**

**Barn Shades**

|                |  |
|----------------|--|
| Shade Style    | Warehouse, Barn Shade                                |
| Shade Diameter | 14"  |
| Available Arms | 10", 14 1/2", 17", 22"                               |
| Use            | Indoor / Outdoor                                     |
| IP Rating      | Wet Location Rated                                   |
| Input Voltage  | 120V AC  |
| Finish         | Architectural Bronze, Satin Black, White, Galvanized |
| Material       | Cold Rolled Steel Die Casted Zinc                    |
| Certification  |  |

Item # **SBL**

**Barn Shades**

|                |  |
|----------------|--|
| Shade Style    | Warehouse, Barn Shade                                |
| Shade Diameter | 17"  |
| Available Arms | 10", 14 1/2", 17", 22"                               |
| Use            | Indoor / Outdoor                                     |
| IP Rating      | Wet Location Rated                                   |
| Input Voltage  | 120V AC  |
| Finish         | Architectural Bronze, Satin Black, White, Galvanized |
| Material       | Cold Rolled Steel Die Casted Zinc                    |
| Certification  |  |

Angle Shades

Item # **SAS**

**Angle Shades**

|                |  |
|----------------|--|
| Shade Style    | Angle Shade  |
| Shade Diameter | 10"  |
| Available Arms | 10", 14 1/2", 17", 22"                               |
| Use            | Indoor / Outdoor                                     |
| IP Rating      | Wet Location Rated                                   |
| Input Voltage  | 120V AC  |
| Finish         | Architectural Bronze, Satin Black, White, Galvanized |
| Material       | Cold Rolled Steel Die Casted Zinc                    |
| Certification  |  |

Wall Sconces

Item # **SAS**

**Wall Sconce Barn Lights**

|                |  |
|----------------|--|
| Shade Style    | Barn Shade   |
| Shade Diameter | 8"   |
| Arm Length     | 6.36"  |
| Use            | Indoor / Outdoor                                     |
| IP Rating      | Wet Location Rated                                   |
| Input Voltage  | 120V AC  |
| Finish         | Architectural Bronze, Satin Black, White, Galvanized |
| Material       | Cold Rolled Steel Die Casted Zinc                    |
| Certification  |  |



Gooseneck Arms & LED Light Bulbs



Gooseneck Arms

|                             |  |
|-----------------------------|--|
| Item #                      | SAS  |
|                             |  |
| <p><b>Gooseneck Arm</b></p> |  |
| Optional Shades             | SAS, SBL   |
| Inside Diameter             | 3/4"   |
| Outside Diameter            | 1"   |
| Arm Length                  | 10"  |
| Arm Height                  | 6"   |
| Use                         | Indoor / Outdoor   |
| Finish                      | Architectural<br>Bronze, Satin Black,<br>White, Galvanized |
| Material                    | Cold Rolled Steel<br>Die Casted Zinc                       |
| Certification               |  |

|                             |  |
|-----------------------------|--|
| Item #                      | SAS  |
|                             |  |
| <p><b>Gooseneck Arm</b></p> |  |
| Optional Shades             | SAS, SBL   |
| Inside Diameter             | 3/4"   |
| Outside Diameter            | 1"   |
| Arm Length                  | 14 1/2"  |
| Arm Height                  | 8"   |
| Use                         | Indoor / Outdoor   |
| Finish                      | Architectural<br>Bronze, Satin Black,<br>White, Galvanized |
| Material                    | Cold Rolled Steel<br>Die Casted Zinc                       |
| Certification               |  |

|                             |  |
|-----------------------------|--|
| Item #                      | SAS  |
|                             |  |
| <p><b>Gooseneck Arm</b></p> |  |
| Optional Shades             | SAS, SBL   |
| Inside Diameter             | 3/4"   |
| Outside Diameter            | 1"   |
| Arm Length                  | 22"  |
| Arm Height                  | 7 1/2"   |
| Use                         | Indoor / Outdoor   |
| Finish                      | Architectural<br>Bronze, Satin Black,<br>White, Galvanized |
| Material                    | Cold Rolled Steel<br>Die Casted Zinc                       |
| Certification               |  |

|                             |  |
|-----------------------------|--|
| Item #                      | SAS  |
|                             |  |
| <p><b>Gooseneck Arm</b></p> |  |
| Optional Shades             | SAS, SBL   |
| Inside Diameter             | 3/4"   |
| Outside Diameter            | 1"   |
| Arm Length                  | 24"  |
| Arm Height                  | 17"  |
| Use                         | Indoor / Outdoor   |
| Finish                      | Architectural<br>Bronze, Satin Black,<br>White, Galvanized |
| Material                    | Cold Rolled Steel<br>Die Casted Zinc                       |
| Certification               |  |

Straight Arm

|                            |  |
|----------------------------|--|
| Item #                     | SGN  |
|                            |  |
| <p><b>Straight Arm</b></p> |  |
| Optional Shades            | SAS, SBL   |
| Inside Diameter            | 3/4"   |
| Outside Diameter           | 1"   |
| Arm Length                 | 13"  |
| Arm Height                 | 2"   |
| Use                        | Indoor / Outdoor   |
| Finish                     | Architectural Bronze,<br>Satin Black, White,<br>Galvanized |
| Material                   | Cold Rolled Steel<br>Die Casted Zinc                       |
| Certification              |  |

LED Light Bulbs

|  |                     |
|--|---------------------|
| Item #                                       | S29589-1            |
| 4-pack                                       | S29589-4            |
|  |                     |
| <p><b>800 Lumen Warm LED Light Bulbs</b></p> |                     |
| Diameter                                     | 2.38"               |
| Finish                                       | Frosted White       |
| Bulb Base Size                               | E26 Medium Base     |
| Bulb Shape                                   | A19                 |
| IP Rating                                    | Damp Location Rated |
| Input Voltage                                | 120V AC             |
| Max Wattage                                  | 9.5W                |
| Dimmable                                     | No                  |
| Lumens                                       | 800                 |
| Hours Rating                                 | 15,000 Hours        |
| Color Temperature                            | 3000k (Warm White)  |

|   |                       |
|---|-----------------------|
| Item #  | S29597-1              |
| 4-pack  | S29597-4              |
|   |                       |
| <p><b>800 Lumen White LED Light Bulbs</b></p> |                       |
| Diameter                                      | 2.38"                 |
| Finish  | Frosted White         |
| Bulb Base Size                                | E26 Medium Base       |
| Bulb Shape                                    | A19                   |
| IP Rating                                     | Damp Location Rated   |
| Input Voltage                                 | 120V AC               |
| Max Wattage                                   | 9.5W                  |
| Dimmable                                      | No                    |
| Lumens  | 800                   |
| Hours Rating                                  | 15,000 Hours          |
| Color Temperature                             | 5000k (Natural White) |

|  |                       |
|--|-----------------------|
| Item #   | S28790-1              |
| 4-pack   | S28790-4              |
|  |                       |
| <p><b>1600 Lumen White LED Light Bulbs</b></p> |                       |
| Diameter                                       | 2.38"                 |
| Finish   | Frosted White         |
| Bulb Base Size                                 | E26 Medium Base       |
| Bulb Shape                                     | A19                   |
| IP Rating                                      | Damp Location Rated   |
| Input Voltage                                  | 120V AC               |
| Max Wattage                                    | 9.5W                  |
| Dimmable                                       | No                    |
| Lumens   | 1600                  |
| Hours Rating                                   | 15,000 Hours          |
| Color Temperature                              | 5000k (Natural White) |





Galvanized Warehouse / Barn Shade with Gooseneck Arm  
Item # SBL14-GA-SGN22-GA



Architectural Bronze Angle Shade Sign Light  
Item # SBL14-BZ-SGN24-BZ



White Angle Shade Sign Lights  
Item # SBL14-WH-SGN22-WH



White Angle Shade  
Item # SAS10-WH







# Standoff Systems

## **STANDOFFS**

|   |     |
|---|-----|
| Aluminum "All In One" Standoffs         | 111 |
| Stainless Steel "All In One" Standoffs  | 111 |
| Color Standoffs                         | 111 |
| Luxury Standoffs                        | 111 |
| Acrylic Standoffs                       | 111 |
| Flat Head Standoffs                     | 112 |
| Hollow Standoffs                        | 112 |
| Special Satin Stainless Steel Standoffs | 112 |
| Stainless Steel Square Standoffs        | 112 |
| LED Standoffs                           | 112 |
| Desktop Standoffs                       | 113 |
| Glass Standoffs                         | 113 |
| Non-Adjustable Edge Grip Standoffs      | 113 |
| Adjustable Edge Grip Standoffs          | 113 |
| Hardware Tools                          | 113 |

|                  |     |
|------------------|-----|
| <b>QUICKSNAP</b> | 114 |
|------------------|-----|

|                   |     |
|-------------------|-----|
| <b>BUTTON-FIX</b> | 120 |
|-------------------|-----|

|                           |     |
|---------------------------|-----|
| <b>Z-CLIP WALL HANGER</b> | 122 |
|---------------------------|-----|

|                              |     |
|------------------------------|-----|
| <b>SUSPENDED SYSTEM KITS</b> | 123 |
|------------------------------|-----|

|                    |     |
|--------------------|-----|
| <b>SIGN SETTER</b> | 124 |
|--------------------|-----|

|                                  |     |
|----------------------------------|-----|
| <b>SIGN HANGERS &amp; PANELS</b> | 125 |
|----------------------------------|-----|

|                                 |     |
|---------------------------------|-----|
| <b>ACRYLIC SIGN HOLDER KITS</b> | 127 |
|---------------------------------|-----|

|                                     |     |
|-------------------------------------|-----|
| <b>ACRYLIC LED SIGN HOLDER KITS</b> | 128 |
|-------------------------------------|-----|

|                            |     |
|----------------------------|-----|
| <b>ART HANGING SYSTEMS</b> | 130 |
|----------------------------|-----|

|   |     |
|---|-----|
| <b>ACRYLIC WALL FRAME SETS WITH STANDOFFS</b> | 132 |
|---|-----|

|                    |     |
|--------------------|-----|
| <b>SNAP FRAMES</b> | 134 |
|--------------------|-----|

|                          |     |
|--------------------------|-----|
| <b>SNAP RAIL HANGERS</b> | 135 |
|--------------------------|-----|

|   |     |
|---|-----|
| <b>STANDOFF &amp; Z-CLIP SAMPLE BOX</b> | 136 |
|---|-----|

|   |     |
|---|-----|
| <b>QUICK SNAP &amp; BUTTON-FIX SAMPLE KIT</b> | 137 |
|---|-----|



## Mbs-Standoffs.com

A standoff system usually consists of barrels, caps, edge-grips, hardware, or grippers. They are made of stainless steel or aluminum. Aside from signs, they are also made to hold glass, panels, photographs, art work, and displays, among other materials. Standoffs hold these materials together horizontally or vertically at a predetermined distance from a surface.



**Mbs-standoffs**

**Aluminum  
"All In One"**

6 Finishes - Design from high quality solid aluminum for indoor & outdoor use.



**Stainless Steel  
"All In One"**

2 Finishes – 3 Different Stainless Steel Grades. Designed from high quality solid stainless steel for indoor & outdoor use.



**Color  
Standoffs**

12 Finishes – Designed from high quality solid aluminum for indoor & outdoor use.



**Luxury  
Standoffs**

3 Finishes – For Indoor and Outdoor Use. Designed from high quality solid aluminum.



**Acrylic  
Standoffs**

2 Finishes – Designed from high quality solid acrylic for indoor and outdoor use.



**Mbs-standoffs**

**Flat Head Standoffs**

3 Different Finishes. Designed from solid stainless steel or aluminum.



**Hollow Standoffs**

6 different diameters, 5 different heights. Designed from hollow stainless steel for indoor use.



**Special Satin Stainless Steel Standoffs**

1/2" Diameter – Designed from high quality stainless steel for indoor and outdoor use.



**LED Standoffs**

Available in 2 or 4 pieces per kit, RGB color changing kits available with over 15 color combinations and 4 modes.



**Stainless Steel Square Standoffs**

Wall mounted standoffs, designed from High Quality Stainless Steel Satin brushed finish for indoor and outdoor use.





**Mbs-standoffs**

**Desktop Standoffs**

Designed from high quality stainless steel Set screw to lock in place Rubber pad base / bottom.



**Glass Standoffs**

Perfect for use with glass wall systems for pools, balconies, stair rails, decks, etc..



**Non- Adjustable Edge Grip Standoffs**

6 Finishes – Stainless Steel For Indoor Use Only, Aluminum For Indoor and Outdoor Use. No mounting holes needed in material.



**Adjustable Edge Grip Standoffs**

6 Finishes – Stainless Steel For Indoor Use only, Aluminum For Indoor and Outdoor use. No mounting holes needed in material.



**Universal Installation Tool Set Dedicated for Signage**

This is the one driver kit that every sign shop technician, store owner, business owner and even home owner must have.



Quick Snap



The Quick Snap system is used for the installation of letters in relief. No drilling no screws visible on the face of the letters. The system is very simple and quick to use.



- ▶ 8 different sizes
- ▶ 4 different colors
- ▶ Adhesive or screw mounted option

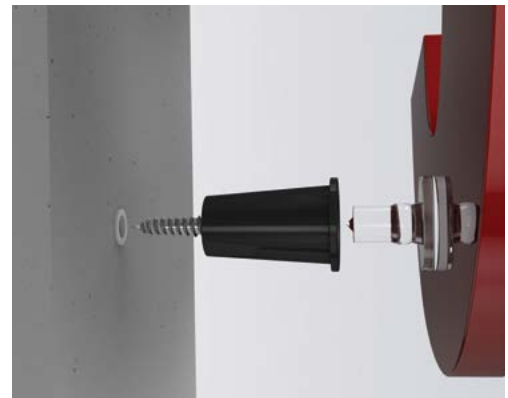

| Maximum Letter Height | Maximum weight per «QS» | Use              | Item      |
|-----------------------|-------------------------|------------------|-----------|
| 7-7/8"                | 0.55 lb (250 g)         | Indoor & outdoor | Mini      |
|                       |                         |                  | Small     |
| 9-13/16"              |                         |                  | Medium    |
|                       |                         |                  | Large     |
| 15-3/4"               | 0.88 lb (400 g)         |                  | Big       |
|                       | 1.54 lb (700 g)         |                  | Extra Big |
| 27-9/16"              |                         |                  | Jumbo     |
|                       |                         |                  | Giant     |



# Quick Snap

## Installation in 5 Easy Steps

The directions below are general installation recommendations. The weight of each fastener depends on the conditions of use. To avoid unnecessary tension it is advised to avoid over tightening of the body support.

### Technical Information

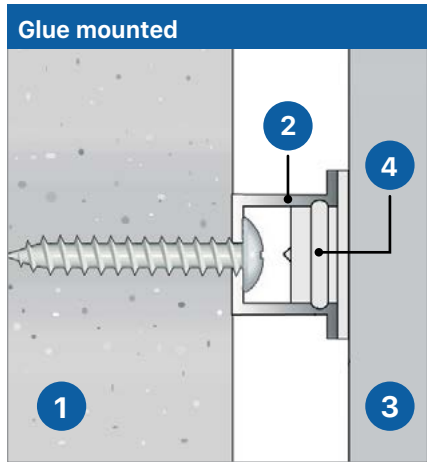

- 1. Surface
- 2. Body with screw
- 3. Letter
- 4. Head with adhesive

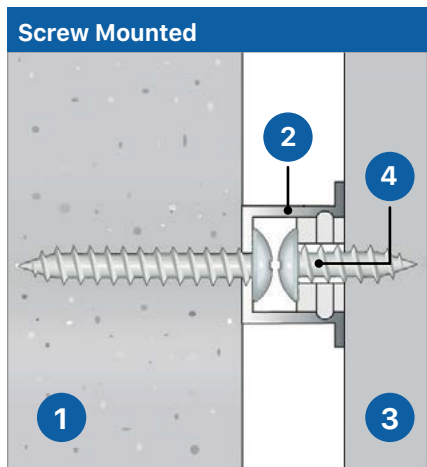

- 1. Surface
- 2. Body with screw
- 3. Letter
- 4. Head with screw

Quick Snap fasteners can be properly secured by using our Quick Snap adhesive for all letters made from acrylic or expanded PVC or by using our 2 component adhesive for letters out of aluminum, brass, stainless or multi layer aluminum enamel.



1

Using adhesive place the Head support on the back of the letters.



2

Place the letter against the template and use pressure to mark placement of pilot holes.



3

Place template and drill appropriately.



4

Attach Body ends in correct positions.



5

Securely Snap the letters into place using slight pressure.



Always use stainless steel screws. Tighten the screws through the fastener, then loosen a quarter of a turn. The fasteners must be used exclusively for letters. Use one fastener per 4"

Quick Snap

Mini

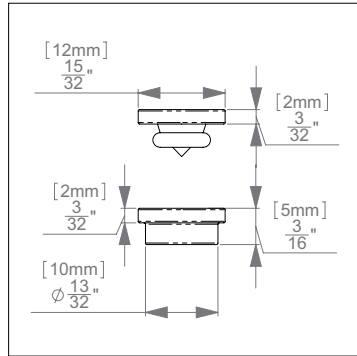

Large / Screw

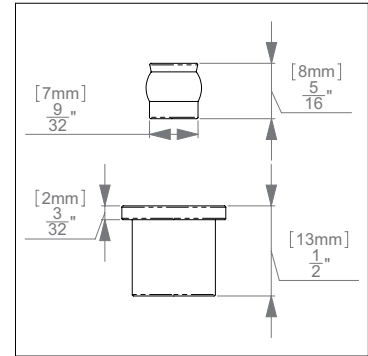

Small

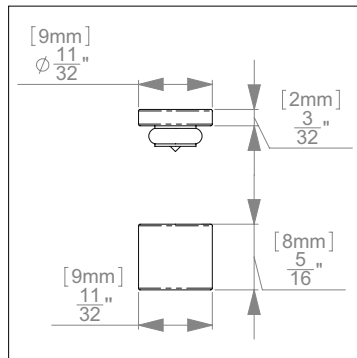

Big

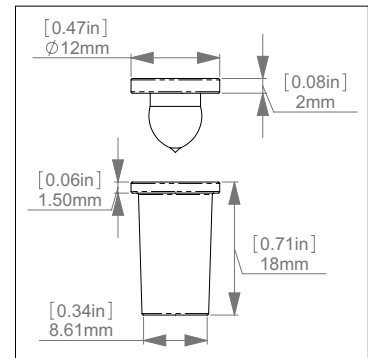

Medium

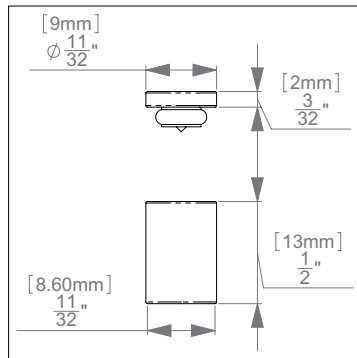

Extra Big

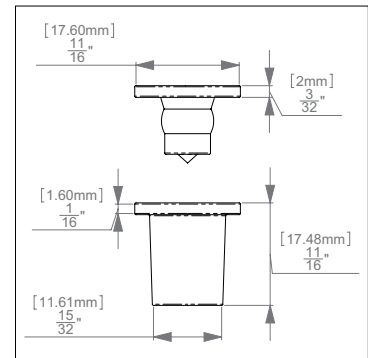

Medium / Adhesive

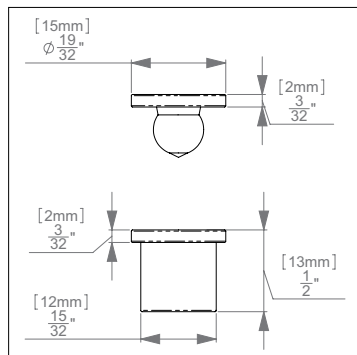

Extra Big / Screw

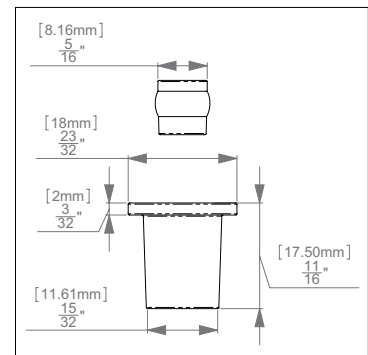

Quick Snap

Jumbo / Adhesive

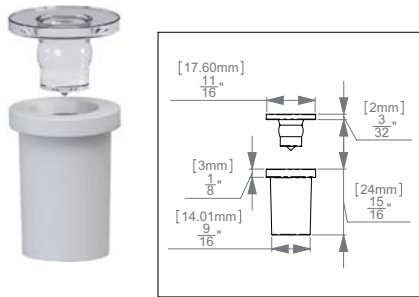

Jumbo / Screw

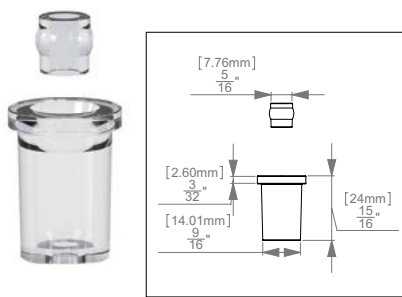

Giant

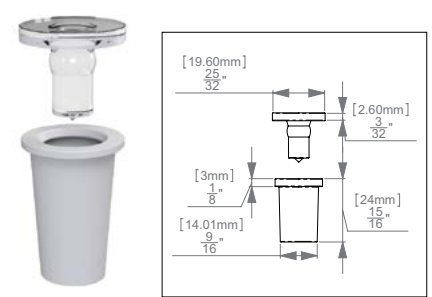

| Name      | Diameter | Rated Strength per Quick Snap | Distance from the wall | Tightening Method     | Black              | White    | Grey     | Clear    |
|-----------|----------|-------------------------------|------------------------|-----------------------|--------------------|----------|----------|----------|
| Mini      | 1/2"     | 0.55 lbs                      | 1/4"                   | Adhesive mounted head | QSASB1HK           | QSASB2HK | QSASB3HK | QSASB4HK |
| Small     | 3/8"     |                               | 3/8"                   |                       | QSBSB1HK           | QSBSB2HK | QSBSB3HK | QSBSB4HK |
| Medium    |          |                               | 1/2"                   |                       | QSCSB1HK           | QSCSB2HK | QSCSB3HK | QSCSB4HK |
| Large     | 5/8"     |                               | 5/8"                   |                       | QSDSB1HK           | QSDSB2HK | QSDSB3HK | QSDSB4HK |
|           |          |                               | 1/2"                   |                       | Screw mounted head | QSDSB1HS | QSDSB2HS | QSDSB3HS |
| Big       | 1/2"     | 3/4"                          | Adhesive mounted head  | QSESB1HK              | QSESB2HK           | QSESB3HK | QSESB4HK |          |
| Extra Big | 3/4"     | 0.88 lbs                      | 3/4"                   | Adhesive mounted head | QFSB1HK            | QFSB2HK  | QFSB3HK  | QFSB4HK  |
|           |          |                               | 3/4"                   | Screw mounted head    | QFSB1HS            | QFSB2HS  | QFSB3HS  | QFSB4HS  |
| Jumbo     |          | 1.54 lbs                      | 1"                     | Adhesive mounted head | QGSB1HK            | QGSB2HK  | QGSB3HK  | QGSB4HK  |
|           |          |                               | 7/8"                   | Screw mounted head    | QGSB1HS            | QGSB2HS  | QGSB3HS  | QGSB4HS  |
| Giant     | 1-1/8"   | 1.54 lbs                      | 1-1/8"                 | Adhesive mounted head | QHSB1HK            | QHSB2HK  | QHSB3HK  | QHSB4HK  |
|           |          |                               | 1-1/16"                | Screw mounted head    | N/A                | N/A      | N/A      | QHSB4HS  |

Sold by the Unit

Sample Kit

Assorted sizes for your review. Refunded with your first order of 250 pcs or more

|            | Item #   |
|------------|----------|
| Sample kit | QSSAMPLE |



Glue

|   |                    | Item #  |
|---|--------------------|---------|
| Quick Snap Letter System Glue             | 0.71 oz (20 gr)    | QSXGLU1 |
| Quick Snap Letter System 2 Component Glue | 1.69 fl oz (50 ml) | QSXGLU2 |



Quick Snap

Item # **QSJSB4H**

**Expander I**

Adjustable standoff from 1-5/8" to 2-1/8"

7/8" Diameter

Adhesive or screw mounted

TREATED ANTI U.V.

Easily removable

Standard: V-2 UL 94 temp. 122 Ca 1.8 Mpa & EN 50107

Clear Color

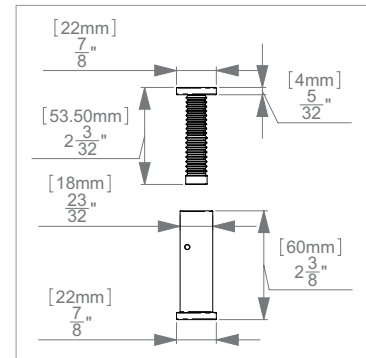

Item # **QSKSB4H**

**Expander I XL**

Adjustable standoff from 1-5/8" to 2-1/8"

1-5/8" Diameter

Adhesive or screw mounted

TREATED ANTI U.V.

Easily removable

Standard: V-2 UL 94 temp. 122 Ca 1.8 Mpa & EN 50107

Clear Color

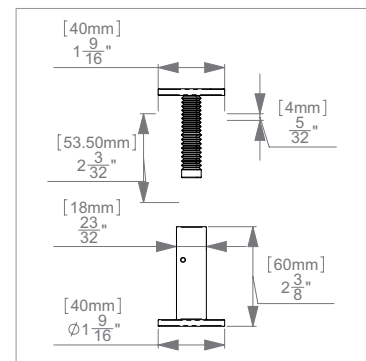

Item # **QLSB4H**

**Expander II**

Adjustable standoff from 2-1/2" to 3-3/8"

7/8" Diameter

Adhesive or screw mounted

Easily removable

TREATED ANTI U.V.

Standard: V-2 UL 94 temp. 122 Ca 1.8 Mpa & EN 50107

Clear Color

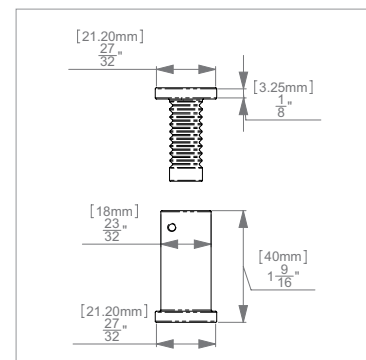

Item # **QSMSB4H**

**Expander II XL**

Adjustable standoff from 2-1/2" to 3-3/8"

1-5/8" Diameter

Adhesive or screw mounted

TREATED ANTI U.V.

Easily removable

Standard: V-2 UL 94 temp. 122 Ca 1.8 Mpa & EN 50107

Clear Color

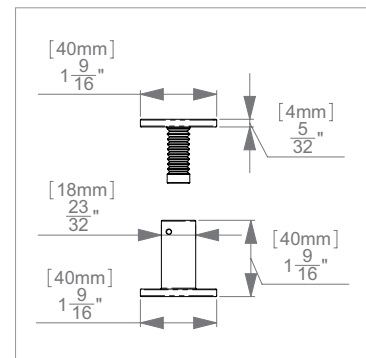



MBS  
SIGNSUPPLY

Milano

DIGITAL  
PAPERS & FILMS

# mbs-signsupply.com

## Get All Prices Through Our Online Store!

Welcome Mbs shoppers to our WEBSITE, Enjoy it and please should you have any questions, call or email us at [contact@mbs-signsupply.com](mailto:contact@mbs-signsupply.com).



1

Log On to [mbs-signsupply.com](http://mbs-signsupply.com)  
You can select the product you are looking for by hovering over each of the categories and choosing a subcategory.

2

Search using filter selection and find the right products!

3

Use all the product tabs to find:

- Description
- Pictures
- Datasheets
- Videos

4

Our new filters make it easy to quickly find the right product. Search using filter selection and find the product for your projects needs.



## Button-fix

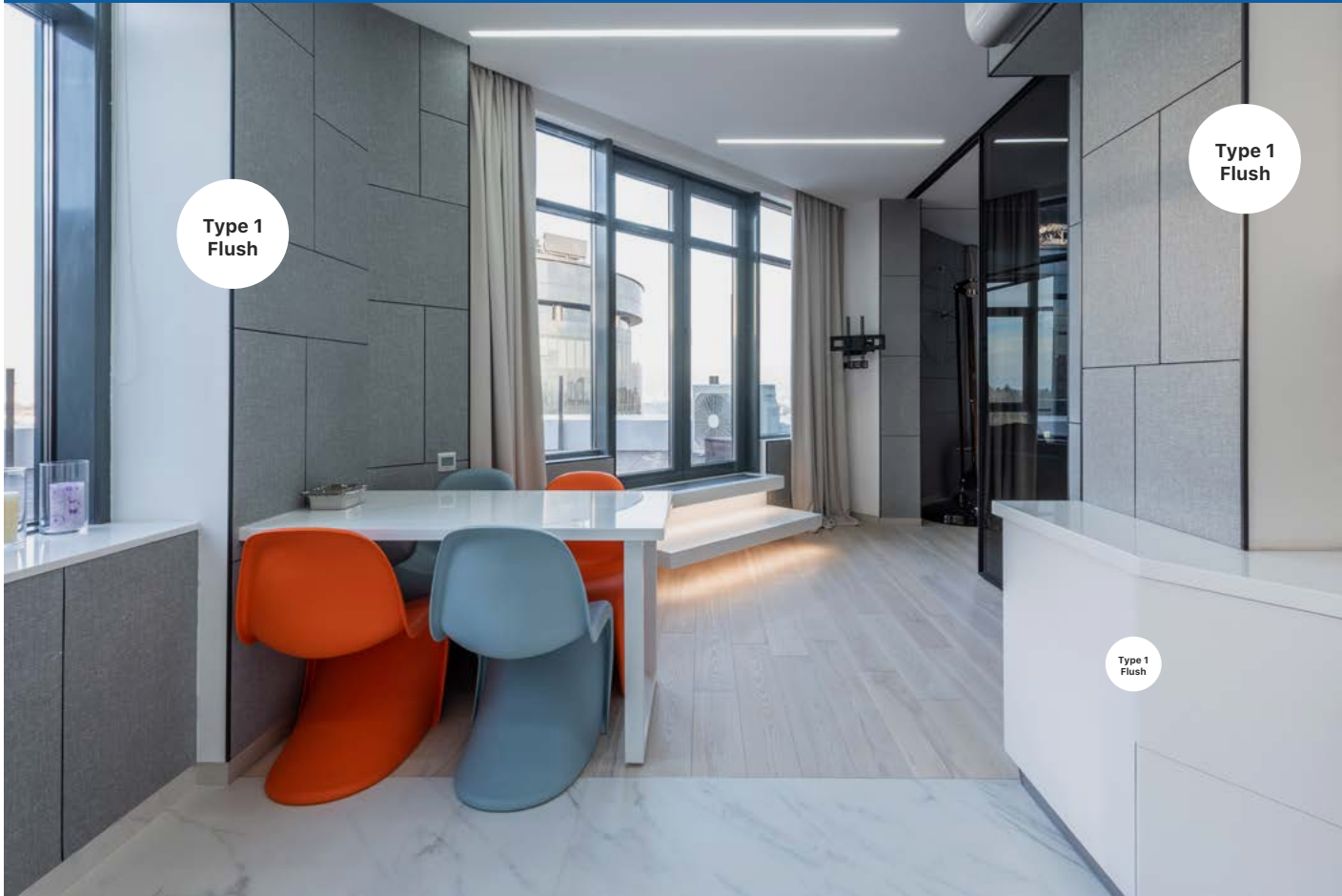

# button-fix

Panel fixing made easy

Button-fix is an easy, accurate and secure method of invisibly attaching panels, signage and objects to walls, ceilings and other surfaces.

- Wall & ceiling panels
- Acoustic panels
- Mirror panels
- Shelf units & shop displays
- Upholstered panels & banquette seating
- No unsightly screws or bolts
- Perfect alignment
- Incredibly strong

## Type 2 & Fix Marker Tool







Router Multijig



Type 1 Bonded



Type 1



Type 1 Flush



### Order Sample Kit!

- Type 1 Flush + CSK Woodscrew button
- Type 1 Fix + CSK Woodscrew button
- Type 1 Bonded + CSK Woodscrew button
- Type 2 Fix + CSK Woodscrew button
- Type 1 Bracket Button Marker
- Fix Marker Tool

Item # 171-001-21



When speed, strength and precision are important, button-fix is the only fix



Type 1

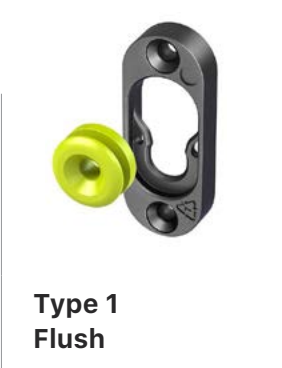

Type 1 Flush

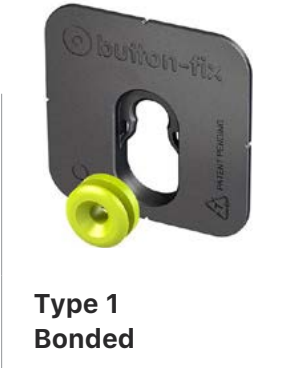

Type 1 Bonded

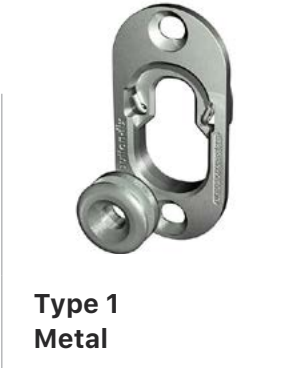

Type 1 Metal



Type 2



Button Marker

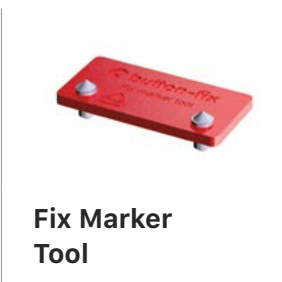

Fix Marker Tool

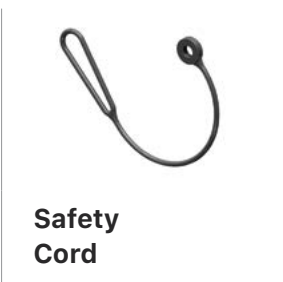

Safety Cord

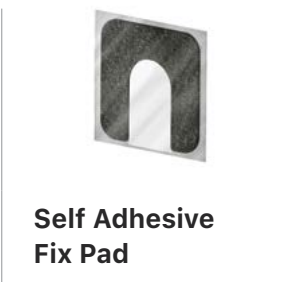

Self Adhesive Fix Pad



Router Multijig

## Z-Clip Wall Panel Hangers



Z-Clip Designed for both pieces of the clips to interlock, securely locking panels in place. Z-Clips are a popular choice for hanging large format projects.



### Common Applications

- ▶ Hanging Wall Panels
- ▶ Partitions
- ▶ Signs
- ▶ Heavy Duty

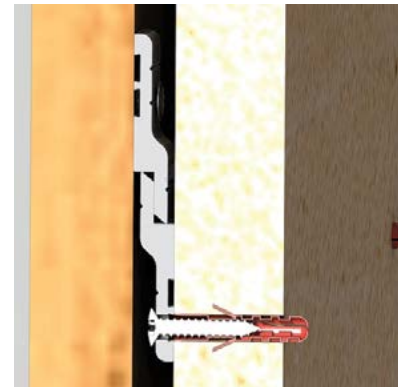

Ideal For Hanging Wall Panels, Partitions, and Signs - All Pre-drilled for Easy Installation

| Length | Height   | Thickness | Number of Holes | Item # |
|--------|----------|-----------|-----------------|--------|
| 2"     |          |           | 2               | ZCP1   |
| 36"    | 1 3/8"   | 1/4"      | 5               | ZCP1-3 |
| 72"    |          |           | 9               | ZCP1-6 |
| 1 1/2" |          |           | 2               | ZCP2   |
| 36"    | 1-13/16" | 3/16"     | 5               | ZCP2-3 |
| 72"    |          |           | 9               | ZCP2-6 |
| 2 1/2" |          |           | 2               | ZCP3   |
| 36"    | 1 1/2"   | 1/4"      | 5               | ZCP3-3 |
| 72"    |          |           | 9               | ZCP3-6 |



Suspended System Kits



Mbs-Signsupply a broad range of high quality suspended systems that perform better than any other.



- ▶ Increased ceiling load, and reduced installation time
- ▶ There is an abundance of kits available – Sky’s the limits!
- ▶ All of our suspended systems have installation guides along with updated YouTube videos to help you along the way
- ▶ We also have certified Sales Reps eager to help
- ▶ Suspended System Parts
- ▶ Suspended Cable Parts
- ▶ Suspended Rod Kits
- ▶ Cable & Rod Hangers
- ▶ Hooks for Stainless Steel and Nylon Cable



Kits



Rods

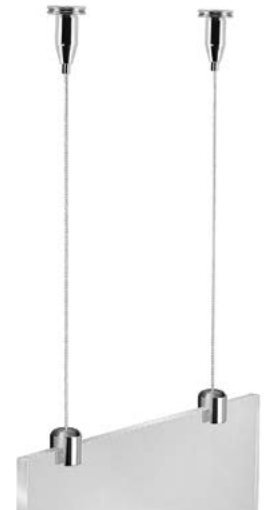

Cables

2 TClamps • 2 Cables • 2 Hooks

| Cable Type            | Diameter | 48"     | 72"     | 96"     | 120"     |
|-----------------------|----------|---------|---------|---------|----------|
| Stainless Steel Cable | 1/16"    | SK1S-48 | SK1S-72 | SK1S-96 | SK1S-120 |
| Nylon Cable           | 1/16"    | SK1N-48 | SK1N-72 | SK1N-96 | SK1N-120 |



Sign Setter



Sign Setter Tool  
for Easy Sign  
Installation



Our amazing new Sign Setter is an amazing tool to dramatically save you time and energy, while ensuring a perfect installation every time! The included professional carrying case will ensure it stays in perfect condition for years to come.

Frames

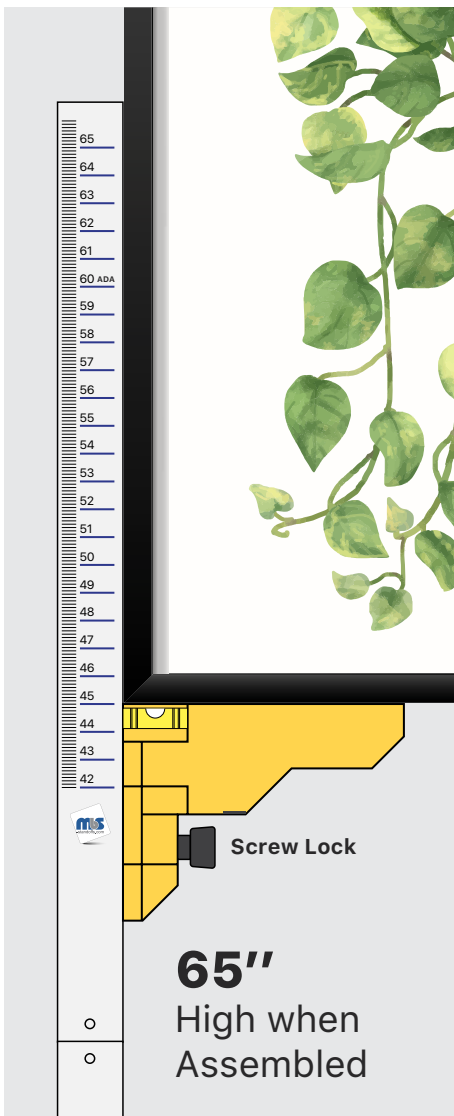

- Comfortable and Easy to Use
- 2-Piece Construction
- Lightweight but extremely durable
- 65" High when Assembled
- ABS Injected Square with Bubble Level and iPhone 6 Holder
- Height Adjustable and ADA Recognized
- High Quality Clear Anodized Aluminum
- High Quality Carrying Case with Handle



Item # SIGNSETTER

Directional Signs

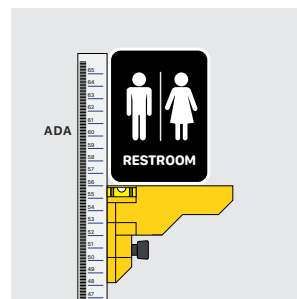

Letter Signs

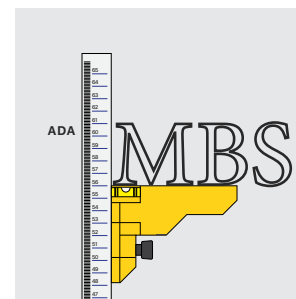

Art Canvas

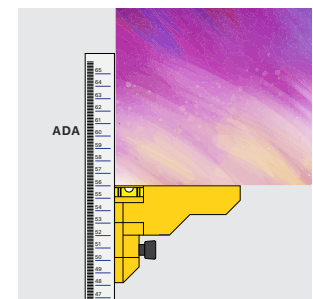

Sign Hangers for Panels & Brackets



High Quality  
Suspended  
Systems



**Sooper Sign Hanger**

- ▶ Bolts through sign.
- ▶ Clean Finish look.

| Dimensions | Material Thickness | Finish       | Material        | Item #     |
|------------|--------------------|--------------|-----------------|------------|
| 1" x 3"    | 1/2"               | Mill         | Stainless Steel | 29511-500  |
|            | 3/4"               |              |                 | 29511-750  |
|            | 1/2"               | White Coated | Aluminum        | 29511-500W |
|            | 3/4"               |              |                 | 29511-750W |



**Sooper Center Brackets**

- ▶ Mount Solid Substrate between post or off wall.
- ▶ Can use Sooper Center Brackets for added strength.
- ▶ Aluminum White Powder Coated finish will not rust.

| Dimensions                  | Material Thickness | Finish       | Material | Item #   |
|-----------------------------|--------------------|--------------|----------|----------|
| 2" H x 2-5/16" W x 1-1/2" D | 1/4"               | White Coated | Aluminum | CBA9025W |
| 2" H x 2-1/2" W x 1-1/2" D  | 1/2"               |              |          | CBA9050W |
| 2" H x 2-3/4" W x 1-1/2" D  | 3/4"               |              |          | CBA9075W |



**Sooper U Brackets**

- ▶ This U shaped end bracket utilized on a wall, desktop or ceiling is quite versatile.
- ▶ For use in all sorts of different mounting applications.

| Dimensions                   | Material Thickness | Finish       | Material        | Item # |
|------------------------------|--------------------|--------------|-----------------|--------|
| 2" H x 2-5/16" W x 1-9/16" D | 1/4"               | Zinc Coated  | Stainless Steel | UB025Z |
| 2" H x 2-1/2" W x 1-9/16" D  | 1/2"               |              |                 | UB050Z |
| 2" H x 2-3/4" W x 1-9/16" D  | 3/4"               |              |                 | UB075Z |
| 2" H x 2-5/16" W x 1-9/16" D | 1/4"               | White Coated | Aluminum        | UB025W |
| 2" H x 2-1/2" W x 1-9/16" D  | 1/2"               |              |                 | UB050W |
| 2" H x 2-3/4" W x 1-9/16" D  | 3/4"               |              |                 | UB075W |



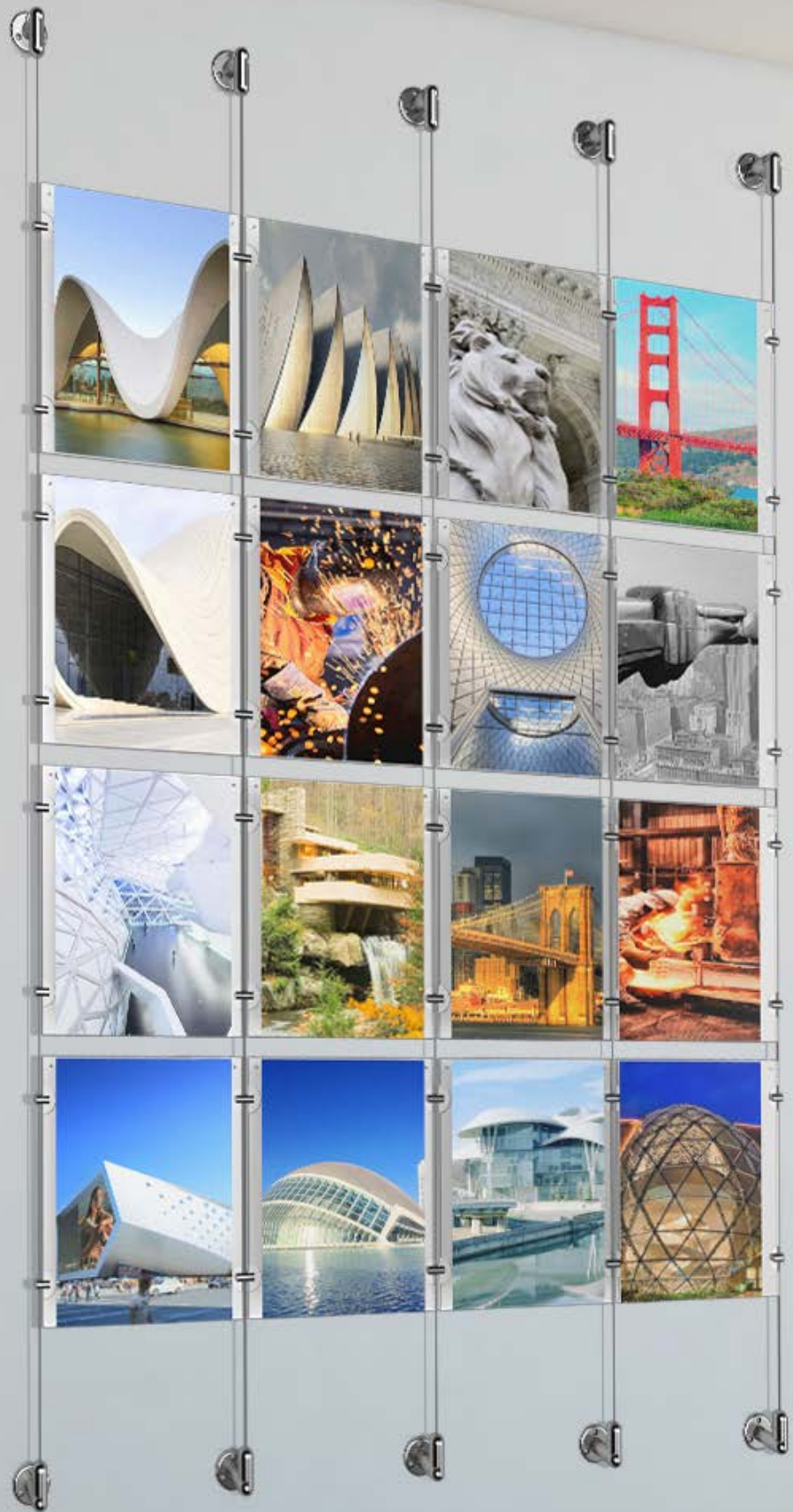

Acrylic Sign Holder Kits



### Sign Holders for Inserts

- ▶ 64 Different Layouts
- ▶ 4 Different Finishes
- ▶ 2 Different Materials
- ▶ Portrait / Landscape
- ▶ 3 Different Installation Types
- ▶ 3 Different Styles

### Row Attached



### Row by Row



Acrylic LED Sign



# Acrylic LED Sign Holder Kits

- Ultra-Bright LED Panel
- Ultra-Slim LED Panel
- No need to change tubes or lamps!
- No visible power supply
- Maintenance Free!



Power Connector for LED Poster Holder  
Item # ACA1212

## LED Light Boxes

The ultra-bright LED panel floats like magic with no visible power supply, drawing people to look at your promotional material. The acrylic display holder is suspended from almost invisible powered cables which are fitted on the wall in on our innovative LED Cable Display Systems. Position the acrylic signs in the window or interior of your premises to make stunning window displays, or use the double sided units to create eye catching partitions within your premises. Transform the appearance of your premises with these ultra slim LED light boxes that are only 3/16" (9 mm) thick. The acrylic LED light box looks different from anything else on the market!

\*Acrylic is not recommended for engraving purposes

| Description  | Item # |
|--|--------|
| LED Poster Holder Kit 1. Single Sided LED Light Pocket Letter Size | KLP1   |
| LED Poster Holder Kit 2. Single Sided LED Light Pocket Letter Size | KLP2   |
| LED Poster Holder Kit 3. Single Sided LED Light Pocket Letter Size | KLP3   |
| LED Poster Holder Kit 4. Single Sided LED Light Pocket Letter Size | KLP4   |

3 Single Sided  
Item # KLP3





Acrylic LED Sign

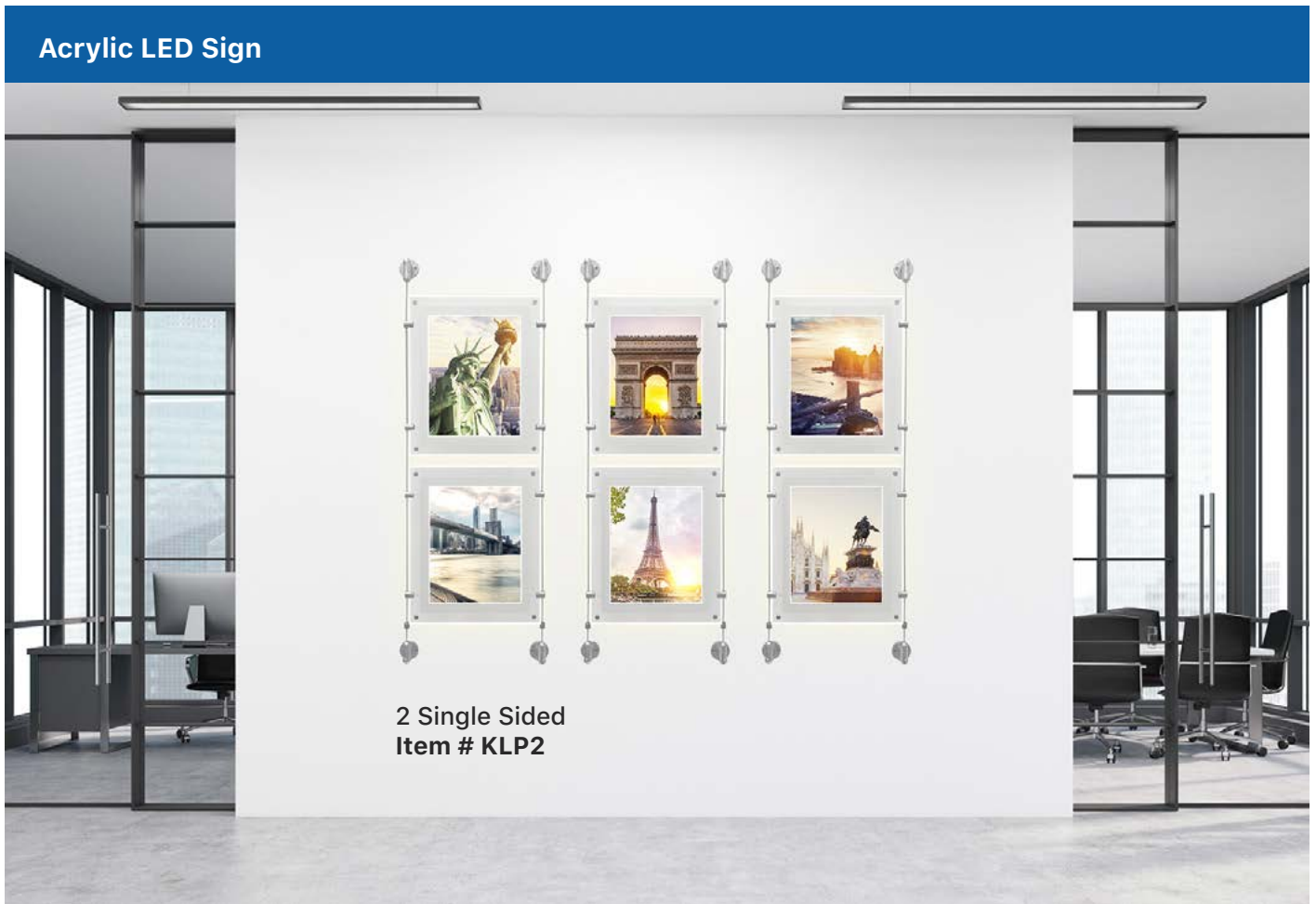

2 Single Sided  
Item # KLP2

Provide an eye catching way to illuminate your posters and photographs that add sparkle and interest drawing attention to your promotional messages.

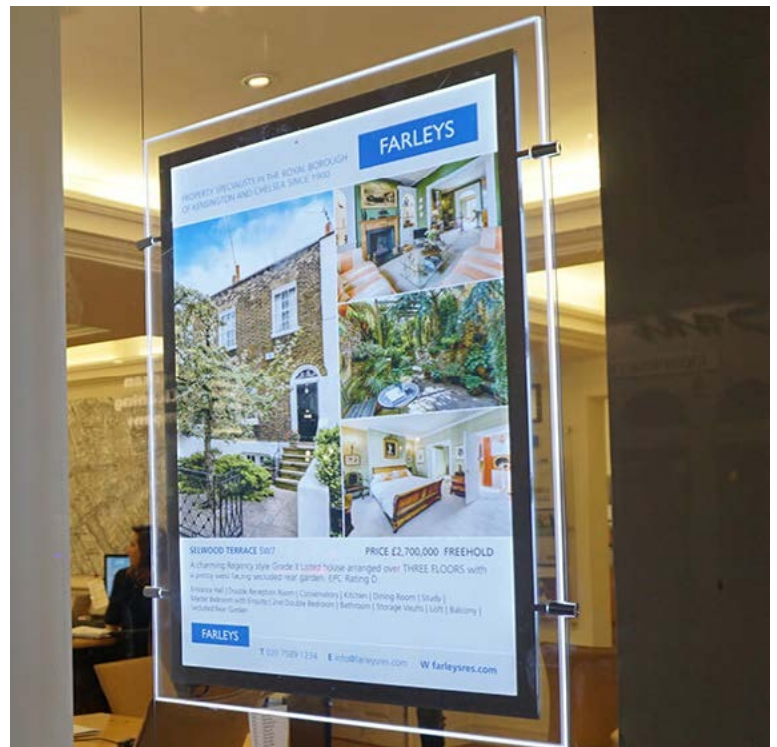

Art Hanging Systems



Ceiling Rail System  
▼

# MBS Hanging Systems

- Museum Quality
- Easy to Install
- Modern, Sleek, and Elegant
- Maintenance Free!



MBS Hanging specializes in hanging systems for Homes and Businesses of all shapes, designs and sizes. We believe that you deserve premium quality at the best price when it comes to hanging art, pictures, signage, and displays.

We work with a wide variety of clients. These clients all have special projects that need a custom look at a great price. Some of our clients include: Museums, Galleries, Hotels, Offices, Retail Spaces, Homes, Airports, Schools, and Public Spaces.



▲  
Classic Rail System



Art Hanging Systems



*At Mbs-Signsupply, we believe the tools we provide should work so well that you don't have to consider how they might have been designed differently. That's why we strive to provide the highest quality professional art hanging products at the best price – every time.*



**Easy Rail System**

Our Easy Rail System is simple, discreet, and designed to use in the home, office, or anywhere that appearance is important.

The key to this beautiful and strong system, rated to withstand loads up to 78 lbs (35 kg), is a series of high strength clips that install behind the rail and out of view.

Thanks to the modular nature of the Easy Rail System, you can add to, remove from, or modify your display at any time in just seconds – and no more holes in the wall!



**Classic Rail System**

Our Classic Rail System is effortless and inconspicuously designed, with a focus on strength, rated to hold up to an astonishing 300 lbs (136 kg) per rail!

The Classic Rail System is designed with galleries in mind, where a display may be changed many times per week.

All of our Hanging Cables and Rods hook on and off in one simple motion to make it easier than ever for you to quickly update your displays!



**Ceiling Rail System**

Our Ceiling Rail System installs into the ceiling instead of the traditional wall mounted application.

Rated Strength 150 lbs (68 Kg). Mount it open-faced to make changing your display easier than ever or turn it around for a closed-face installation that makes your Art Hanging System even more subtle than before. Use it in the window of your shop or use it a few inches off of the wall to give your art an amazing floating effect!

Acrylic Wall Frame Sets with Standoffs



Our Deluxe Acrylic Standoff Frames feature high quality acrylic panels giving your frame a clearer-than-glass appearance.



# Create!

your own  
Stylish Acrylic  
Wall Frames Sets



Choose from:  
7 different frame sizes and combine  
them with any color choice of standoffs.

|  |                   |  |                    |
|--|-------------------|--|--------------------|
| <p><b>Step 1</b><br/>Pick a<br/>Frame Size</p> | 7 1/2" x 9 1/2"   | <p><b>Step 2</b><br/>Choose Color<br/>of Standoffs</p> | Black Anodized     |
|  | 11" x 13 1/2"     |  | Champagne Anodized |
|  | 13 1/2" x 16 1/2" |  | Gold Anodized      |
|  | 13 1/2" x 19 1/2" |  | Silver Anodized    |
|  | 19 3/4" x 26"     |  | Polished           |
|  | 23 3/4" x 29 3/4" |  | Stain Brushed      |
|  | 27" x 39"         |  |                    |



# STANDOFF SYSTEMS

Item # **WAC0507-C**



## 7 1/2" x 9 1/2" Clear Acrylic Wall Frame with Insert

Width 7 1/2"  
Height 9 1/2"  
Inset Size 5" x 7"  
Thickness 1/8"

Item # **WAC8511-C**



## 11" x 13 1/2" Clear Acrylic Wall Frame with Insert

Width 11 1/2"  
Height 13 1/2"  
Inset Size 8 1/2" x 11"  
Thickness 1/8"

Item # **WAC1114-C**



## 13 1/2" Clear Acrylic Wall Frames with Inserts

|                  |   |
|------------------|---|
| <b>WAC1114-C</b> | Frame 13 1/2" x 16 1/2"<br>Insert 11" x 14" |
| <b>WAC1117-C</b> | Frame 13 1/2" x 19 1/2"<br>Insert 11" x 17" |
| <b>Thickness</b> | 1/8"  |

Item # **WAC1824-C**



## 19 3/4" x 26" Clear Acrylic Wall Frame with Insert

Width 19 1/2"  
Height 26 1/2"  
Inset Size 18" x 24"  
Thickness 3/16"

Item # **WAC2228-C**



## 23 3/4" x 29 3/4" Clear Acrylic Wall Frame with Insert

Width 23 3/4"  
Height 29 3/4"  
Inset Size 22" x 28"  
Thickness 3/16"

Item # **WAC2436-C**



## 27" x 39" Clear Acrylic Wall Frame with Insert

Width 27"  
Height 39"  
Inset Size 24" x 36"  
Thickness 3/16"

Item # **AS16-12BK**



## 5/8" Black Anodized Aluminum Standoff

Diameter 5/8"  
Distance from Wall 1/2"  
Area of Use Indoor  
Grade 6063

Item # **AS16-12BR**



## 5/8" Champagne Anodized Aluminum Standoff

Diameter 5/8"  
Distance from Wall 1/2"  
Area of Use Indoor  
Grade 6063

Item # **AS16-12GD**



## 5/8" Gold Anodized Aluminum Standoff

Diameter 5/8"  
Distance from Wall 1/2"  
Area of Use Indoor  
Grade 6063

Item # **AS16-12SL**



## 5/8" Silver Anodized Aluminum Standoff

Diameter 5/8"  
Distance from Wall 1/2"  
Area of Use Indoor  
Grade 6063

Item # **SBLP16-12**



## 5/8" Polished Stainless Steel Standoff

Diameter 5/8"  
Distance from Wall 1/2"  
Area of Use Indoor  
Grade 201

Item # **SBLS16-12**



## 5/8" Satin Brushed Stainless Steel Standoff

Diameter 5/8"  
Distance from Wall 1/2"  
Area of Use Indoor  
Grade 201



Snap Frames



**High-Quality Aluminum Construction**

Easy Front Loading System

- Multi-Purpose use
- Lightweight Pvc Protector Inc.
- Thin Profile

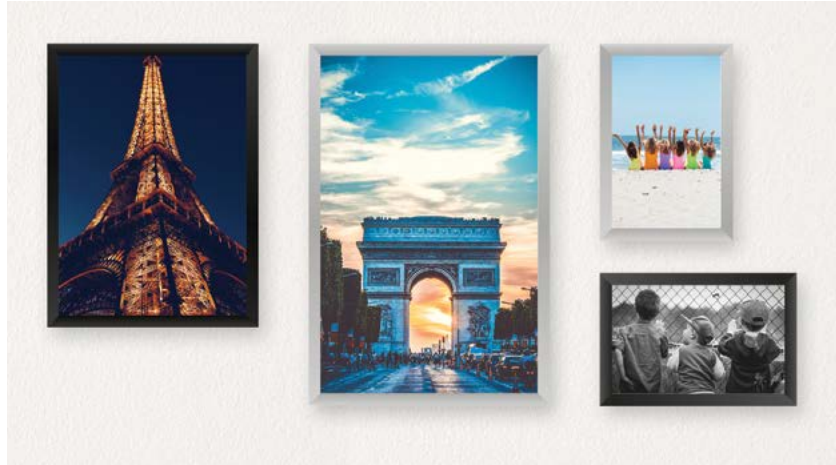

**Quick Changing Frame**

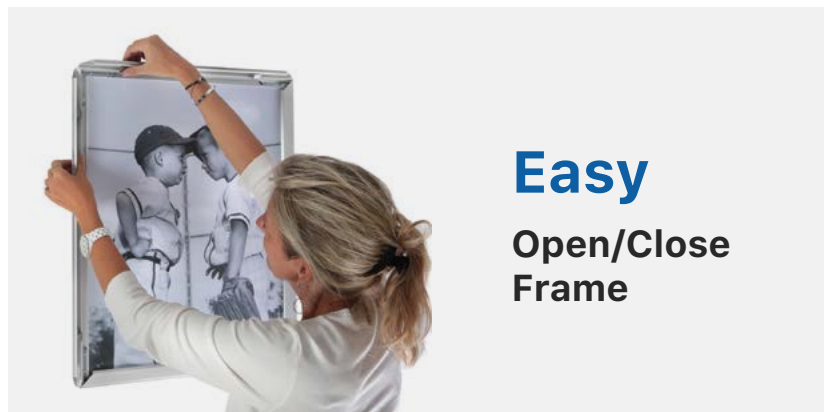

**Easy Open/Close Frame**

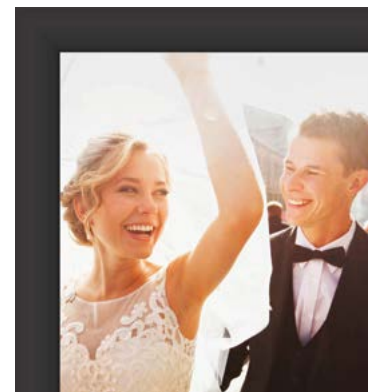

| Frame Size        | Profile | Insert Size | Aluminum | Black   |
|-------------------|---------|-------------|----------|---------|
| 12 1/2" x 18 1/2" | 1.25"   | 11" x 17"   | ALSF001  | ALSF002 |
| 19 1/2" x 25 1/2" | 1.25"   | 18" x 24"   | ALSF003  | ALSF004 |
| 23 1/2" x 29 1/2" | 1.25"   | 22" x 28"   | ALSF005  | ALSF006 |
| 23 1/2" x 29 1/2" | 1.00"   | 22" x 28"   | N/A      | ALSF007 |
| 25 1/2" x 37 1/2" | 1.25"   | 24" x 36"   | ALSF008  | ALSF009 |
| 28 1/2" x 41 1/2" | 1.25"   | 27" x 40"   | ALSF010  | ALSF011 |
| 31 1/2" x 41 1/2" | 1.25"   | 30" x 40"   | ALSF012  | ALSF013 |
| 37 1/2" x 49 1/2" | 1.25"   | 36" x 48"   | ALSF014  | ALSF015 |
| 41 1/2" x 61 1/2" | 1.25"   | 40" x 60"   | ALSF016  | ALSF017 |



Snap Rail Hangers



**High-Quality Display Rails**  
 Enjoy quick changing systems to change from one piece to another with ease. Choose from 3 styles.



Our Aluminum Display Rails are amazingly designed for ease of use and versatility for any purpose.

Item # **APP**



**Aluminum Rails with Locking Rollers**

| Length | Item # |
|--------|--------|
| 8.5"   | AAP85  |
| 11"    | AAP11  |
| 18"    | AAP18  |
| 22"    | AAP22  |
| 24"    | AAP24  |
| 27"    | AAP27  |
| 30"    | AAP30  |
| 48"    | AAP48  |
| 72"    | AAP72  |

The Aluminum Display Rail is the perfect alternative to a typical bulletin. It eliminates the need for tacks and pins, which means it won't leave unsightly holes or damage your materials.

Item # **ABR**



**2 Piece Aluminum Snap Rails with Spring Mechanism**

| Length | Item # |
|--------|--------|
| 8.5"   | ABR85  |
| 11"    | ABR11  |
| 18"    | ABR18  |
| 22"    | ABR22  |
| 24"    | ABR24  |
| 27"    | ABR27  |
| 30"    | ABR30  |
| 48"    | ABR48  |
| 72"    | ABR72  |

Simply level your display rail and mark your holes. Next, install your anchors, line your display rail up, and screw it into place. Now you are ready to start hanging up your artwork! Just un-snap the rail, insert your material, then snap it back into place and VOILA!

Item # **SCP**



**Clear Plastic Snap Rail**

| Length | Item # |
|--------|--------|
| 8.5"   | SCP85  |
| 11"    | SCP11  |
| 18"    | SCP18  |
| 22"    | SCP22  |
| 24"    | SCP24  |
| 27"    | SCP27  |
| 30"    | SCP30  |
| 36"    | SCP36  |
| 48"    | SCP48  |
| 72"    | SCP72  |

Great for wide papers, posters and banners. Quick changing display and elegant design. Easy open/close and reusable system



Standoffs and Z-Clip Sample Boxes

# Standoffs

## Sample Box

12 Finishes for Indoor and Outdoor Use



Our compact Sample Box of Standoffs is the perfect display tool to take with you to show to your customers the great quality products that they'll be receiving.

Item # ASSAMPBOX

# Z-Clip French Cleat

## Sample Box

ZCP Sample Box with 2 Pieces of

- ZCP1,
- ZCP2,
- ZCP3;

Instruction Guide and Description



Our compact Z Clip Sample Box of French Cleat is the perfect display tool to take with you to show to your customers the great quality products that they'll be receiving.

Item # ZCPSAMPLEBOX



Quick-Snap and Button-fix Sample Kits

# Quick-Snap

## Sample Bag

Try out our Quick Snap Sample Bag

Item # QSSAMPLE



**5 Easy steps to Install!**  
See Page 114



Assorted sizes for your review. Refunded with your first order of 250 pcs or more.

# button-fix

## Sample Kit

- Type 1 Flush + CSK Woodscrew button
- Type 1 Fix + CSK Woodscrew button
- Type 1 Bonded + CSK Woodscrew button
- Type 2 Fix + CSK Woodscrew button
- Type 1 Bracket Button Marker
- Fix Marker Tool



Button-fix is an easy, accurate and secure method of invisibly attaching panels, signage and objects to walls, ceilings and other surfaces.

Item # 171-001-21

**Brewhaus**  
Fine Spirits  
Est. 1994

# Sign Brackets & Blanks



## SIGN BRACKETS

|  |     |
|--|-----|
| Flat Bar Bracket                                 | 140 |
| Reverse Scroll Ball Finial Bracket               | 140 |
| Reverse Scroll Fleur De Lis Finial Bracket       | 140 |
| Reverse Scroll Pineapple Finial Bracket          | 140 |
| Reverse Scroll Spear Point Bracket               | 140 |
| Ceiling Mount Ball Finial Bracket                | 140 |
| Ceiling Mount Fleur De Lis Finial Bracket        | 140 |
| Ceiling Mount Spear Point Bracket                | 140 |
| Ceiling Mount Spear Point Finial Bracket         | 140 |
| Curved Arm Ball Finial Bracket                   | 141 |
| Curved Arm Fleur De Lis Finial Bracket           | 141 |
| Curved Arm Pineapple Finial Bracket              | 141 |
| Straight Arm Ball Finial Bracket (Black)         | 141 |
| Straight Arm Fleur De Lis Finial Bracket (Black) | 141 |
| Straight Arm Pineapple Finial Bracket (Black)    | 141 |
| Straight Arm Spear Point Finial Bracket (Black)  | 141 |
| Straight Arm Ball Finial Bracket (Gray)          | 141 |
| Straight Arm Fleur De Lis Finial Bracket (Gray)  | 141 |
| Straight Arm Pineapple Finial Bracket (Gray)     | 142 |
| Straight Arm Spear Point Finial Bracket (Gray)   | 142 |
| Super Deluxe Quin Spiral Ball Finial Bracket     | 142 |
| Deluxe Bracket                                   | 142 |
| Double Mount Bracket                             | 142 |
| Sign Hanging Hardware                            | 142 |
| Black Powder Coated S Hooks                      | 142 |

## PRE-CUT SIGN BLANKS

|                       |     |
|-----------------------|-----|
| Rectangle Sign Blanks | 143 |
| Oval Sign Blanks      | 143 |

## CORRUGATED BOARDS

|                                  |     |
|----------------------------------|-----|
| White Corrugated Plastic Boards  | 144 |
| Yellow Corrugated Plastic Boards | 144 |

## FOAM BOARDS

|                   |     |
|-------------------|-----|
| White Foam Boards | 145 |
| Black Foam Boards | 145 |

**Flat Bar Bracket**



**Flat Bar Bracket**

|                 |                     |                         |
|-----------------|---------------------|-------------------------|
| Available Sizes | 24" x 12"           | Ring Spacing 14" (± ½") |
|                 | 36" x 14"           | Ring Spacing 22" (± ½") |
|                 | 48" x 14"           | Ring Spacing 30" (± ½") |
| Material        | Steel               |                         |
| Finish          | Black Powder Coated |                         |
| Style           | Flat Bar            |                         |
| Duty            | Light to Medium     |                         |

**Reverse Scroll Bracket**



**Reverse Scroll Ball Finial Bracket**

|                 |                              |                         |
|-----------------|------------------------------|-------------------------|
| Available Sizes | 24" x 12"                    | Ring Spacing 14" (± ½") |
|                 | 43" x 14"                    | Ring Spacing 22" (± ½") |
|                 | 48" x 14"                    | Ring Spacing 30" (± ½") |
| Material        | Steel                        |                         |
| Finish          | Black Powder Coated          |                         |
| Style           | Squared Spiral / Ball Finial |                         |
| Duty            | Heavy                        |                         |



**Reverse Scroll Fleur De Lis Finial Bracket**

|                 |                                      |                         |
|-----------------|--------------------------------------|-------------------------|
| Available Sizes | 24" x 12"                            | Ring Spacing 14" (± ½") |
|                 | 36" x 14"                            | Ring Spacing 22" (± ½") |
|                 | 48" x 14"                            | Ring Spacing 30" (± ½") |
| Material        | Steel                                |                         |
| Finish          | Black Powder Coated                  |                         |
| Style           | Squared Spiral / Fleur De Lis Finial |                         |
| Duty            | Heavy                                |                         |



**Reverse Scroll Pineapple Finial Bracket**

|                 |                                   |                         |
|-----------------|-----------------------------------|-------------------------|
| Available Sizes | 24" x 12"                         | Ring Spacing 14" (± ½") |
|                 | 43" x 14"                         | Ring Spacing 22" (± ½") |
|                 | 48" x 14"                         | Ring Spacing 30" (± ½") |
| Material        | Steel                             |                         |
| Finish          | Black Powder Coated               |                         |
| Style           | Squared Spiral / Pineapple Finial |                         |
| Duty            | Light to Medium                   |                         |

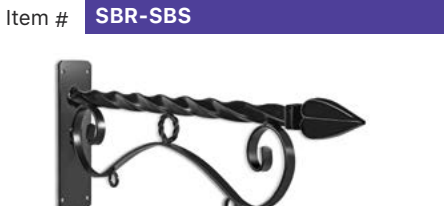

**Reverse Scroll Spear Point Bracket**

|                 |                                      |                         |
|-----------------|--------------------------------------|-------------------------|
| Available Sizes | 24" x 12"                            | Ring Spacing 14" (± ½") |
|                 | 43" x 14"                            | Ring Spacing 22" (± ½") |
|                 | 48" x 14"                            | Ring Spacing 30" (± ½") |
| Material        | Steel                                |                         |
| Finish          | Black Powder Coated                  |                         |
| Style           | Squared Spiral / Spear Point Bracket |                         |
| Duty            | Heavy                                |                         |

**Ceiling Mount Bracket**



**Ceiling Mount Ball Finial Bracket**

|                 |                              |                         |
|-----------------|------------------------------|-------------------------|
| Available Sizes | 24" x 9"                     | Ring Spacing 14" (± ½") |
|                 | 36" x 12"                    | Ring Spacing 23" (± ½") |
|                 | 48" x 12"                    | Ring Spacing 30" (± ½") |
| Material        | Steel                        |                         |
| Finish          | Black Powder Coated          |                         |
| Style           | Squared Spiral / Ball Finial |                         |
| Duty            | Medium                       |                         |



**Ceiling Mount Fleur De Lis Finial Bracket**

|                 |                                      |                         |
|-----------------|--------------------------------------|-------------------------|
| Available Sizes | 24" x 9"                             | Ring Spacing 14" (± ½") |
|                 | 43" x 12"                            | Ring Spacing 22" (± ½") |
|                 | 48" x 12"                            | Ring Spacing 30" (± ½") |
| Material        | Steel                                |                         |
| Finish          | Black Powder Coated                  |                         |
| Style           | Squared Spiral / Fleur De Lis Finial |                         |
| Duty            | Medium                               |                         |



**Ceiling Mount Spear Point Bracket**

|                 |                                      |                         |
|-----------------|--------------------------------------|-------------------------|
| Available Sizes | 24" x 9"                             | Ring Spacing 14" (± ½") |
|                 | 43" x 12"                            | Ring Spacing 22" (± ½") |
|                 | 48" x 12"                            | Ring Spacing 30" (± ½") |
| Material        | Steel                                |                         |
| Finish          | Black Powder Coated                  |                         |
| Style           | Squared Spiral / Spear Point Bracket |                         |
| Duty            | Medium                               |                         |



**Ceiling Mount Spear Point Finial Bracket**

|                 |                                     |                         |
|-----------------|-------------------------------------|-------------------------|
| Available Sizes | 24" x 9"                            | Ring Spacing 14" (± ½") |
|                 | 43" x 12"                           | Ring Spacing 23" (± ½") |
|                 | 48" x 12"                           | Ring Spacing 30" (± ½") |
| Material        | Steel                               |                         |
| Finish          | Black Powder Coated                 |                         |
| Style           | Squared Spiral / Spear Point Finial |                         |
| Duty            | Medium                              |                         |

**■ Curved**

Item # **SBCD-SBB**



**Curved Arm Ball Finial Bracket**

|                 |                              |                         |
|-----------------|------------------------------|-------------------------|
| Available Sizes | 24" x 11"                    | Ring Spacing 14" (± ½") |
|                 | 36" x 14"                    | Ring Spacing 22" (± ½") |
|                 | 48" x 14"                    | Ring Spacing 30" (± ½") |
| Material        | Steel                        |                         |
| Finish          | Black Powder Coated          |                         |
| Style           | Squared Spiral / Ball Finial |                         |
| Duty            | Heavy                        |                         |

Item # **SBCD-SBF**



**Curved Arm Fleur De Lis Finial Bracket**

|                 |                                      |                         |
|-----------------|--------------------------------------|-------------------------|
| Available Sizes | 24" x 11"                            | Ring Spacing 14" (± ½") |
|                 | 36" x 14"                            | Ring Spacing 22" (± ½") |
|                 | 48" x 14"                            | Ring Spacing 30" (± ½") |
| Material        | Steel                                |                         |
| Finish          | Black Powder Coated                  |                         |
| Style           | Squared Spiral / Fleur De Lis Finial |                         |
| Duty            | Heavy                                |                         |

Item # **SBSD-SBP**



**Curved Arm Pineapple Finial Bracket**

|                 |                                   |                         |
|-----------------|-----------------------------------|-------------------------|
| Available Sizes | 24" x 11"                         | Ring Spacing 14" (± ½") |
|                 | 36" x 14"                         | Ring Spacing 22" (± ½") |
|                 | 48" x 14"                         | Ring Spacing 30" (± ½") |
| Material        | Steel                             |                         |
| Finish          | Black Powder Coated               |                         |
| Style           | Squared Spiral / Pineapple Finial |                         |
| Duty            | Heavy                             |                         |

**■ Straight Arm**

Item # **SBSS-SBB**



**Straight Arm Ball Finial Bracket**

|                 |                             |                         |
|-----------------|-----------------------------|-------------------------|
| Available Sizes | 24" x 12"                   | Ring Spacing 14" (± ½") |
|                 | 36" x 14"                   | Ring Spacing 22" (± ½") |
|                 | 48" x 14"                   | Ring Spacing 30" (± ½") |
| Material        | Steel                       |                         |
| Finish          | Black Powder Coated         |                         |
| Style           | Square Tubing / Ball Finial |                         |
| Duty            | Heavy                       |                         |

Item # **SBSS-SBF**



**Straight Arm Fleur De Lis Finial Bracket**

|                 |                                     |                         |
|-----------------|-------------------------------------|-------------------------|
| Available Sizes | 24" x 12"                           | Ring Spacing 14" (± ½") |
|                 | 36" x 14"                           | Ring Spacing 22" (± ½") |
|                 | 48" x 14"                           | Ring Spacing 30" (± ½") |
| Material        | Steel                               |                         |
| Finish          | Gray Powder Coated                  |                         |
| Style           | Square Tubing / Fleur De Lis Finial |                         |
| Duty            | Heavy                               |                         |

Item # **SBSS-SBP**



**Straight Arm Pineapple Finial Bracket**

|                 |                                  |                         |
|-----------------|----------------------------------|-------------------------|
| Available Sizes | 24" x 12"                        | Ring Spacing 14" (± ½") |
|                 | 36" x 14"                        | Ring Spacing 22" (± ½") |
|                 | 48" x 14"                        | Ring Spacing 30" (± ½") |
| Material        | Steel                            |                         |
| Finish          | Black Powder Coated              |                         |
| Style           | Square Tubing / Pineapple Finial |                         |
| Duty            | Heavy                            |                         |

Item # **SBSS-SBS**



**Straight Arm Spear Point Finial Bracket**

|                 |                                    |                         |
|-----------------|------------------------------------|-------------------------|
| Available Sizes | 24" x 12"                          | Ring Spacing 14" (± ½") |
|                 | 36" x 14"                          | Ring Spacing 22" (± ½") |
|                 | 48" x 14"                          | Ring Spacing 30" (± ½") |
| Material        | Steel                              |                         |
| Finish          | Black Powder Coated                |                         |
| Style           | Square Tubing / Spear Point Finial |                         |
| Duty            | Heavy                              |                         |

Item # **SBSS-SGB**



**Straight Arm Ball Finial Bracket**

|                 |                             |                         |
|-----------------|-----------------------------|-------------------------|
| Available Sizes | 24" x 12"                   | Ring Spacing 14" (± ½") |
|                 | 36" x 14"                   | Ring Spacing 22" (± ½") |
|                 | 48" x 14"                   | Ring Spacing 30" (± ½") |
| Material        | Steel                       |                         |
| Finish          | Gray Powder Coated          |                         |
| Style           | Square Tubing / Ball Finial |                         |
| Duty            | Heavy                       |                         |

Item # **SBSS-SGF**



**Straight Arm Fleur De Lis Finial Bracket**

|                 |                                     |                         |
|-----------------|-------------------------------------|-------------------------|
| Available Sizes | 24" x 12"                           | Ring Spacing 14" (± ½") |
|                 | 36" x 14"                           | Ring Spacing 22" (± ½") |
|                 | 48" x 14"                           | Ring Spacing 30" (± ½") |
| Material        | Steel                               |                         |
| Finish          | Gray Powder Coated                  |                         |
| Style           | Square Tubing / Fleur De Lis Finial |                         |
| Duty            | Heavy                               |                         |

**Deluxe**

Item # **SBSS-SBS**



**Straight Arm Pineapple Finial Bracket**

|                 |                                  |                         |
|-----------------|----------------------------------|-------------------------|
| Available Sizes | 24" x 12"                        | Ring Spacing 14" (± ½") |
|                 | 36" x 14"                        | Ring Spacing 22" (± ½") |
|                 | 48" x 14"                        | Ring Spacing 30" (± ½") |
| Material        | Steel                            |                         |
| Finish          | Black Powder Coated              |                         |
| Style           | Square Tubing / Pineapple Finial |                         |
| Duty            | Heavy                            |                         |

Item # **SBSS-SGS**



**Straight Arm Spear Point Finial Bracket**

|                 |                                    |                         |
|-----------------|------------------------------------|-------------------------|
| Available Sizes | 24" x 12"                          | Ring Spacing 14" (± ½") |
|                 | 36" x 14"                          | Ring Spacing 22" (± ½") |
|                 | 48" x 14"                          | Ring Spacing 30" (± ½") |
| Material        | Steel                              |                         |
| Finish          | Gray Powder Coated                 |                         |
| Style           | Square Tubing / Spear Point Finial |                         |
| Duty            | Heavy                              |                         |

Item # **SBSD-SBB**



**Super Deluxe Quin Spiral Ball Finial Aluminum Bracket**

|                 |                              |                         |
|-----------------|------------------------------|-------------------------|
| Available Sizes | 24" x 11"                    | Ring Spacing 30" (± ½") |
|                 | 36" x 14"                    | Ring Spacing 40" (± ½") |
|                 | 48" x 14"                    | Ring Spacing 50" (± ½") |
| Material        | Aluminum                     |                         |
| Finish          | Black Powder Coated          |                         |
| Style           | Squared Spiral / Ball Finial |                         |
| Duty            | Heavy                        |                         |

**Double Mount**

Item # **SBSD-ABB**



**Deluxe Bracket**

|                 |                              |                         |
|-----------------|------------------------------|-------------------------|
| Available Sizes | 48" x 18"                    | Ring Spacing 30" (± ½") |
|                 | 60" x 26"                    | Ring Spacing 40" (± ½") |
|                 | 72" x 26"                    | Ring Spacing 50" (± ½") |
| Material        | Aluminum                     |                         |
| Finish          | Black Powder Coated          |                         |
| Style           | Squared Spiral / Ball Finial |                         |
| Duty            | Heavy                        |                         |

Item # **SBDM**



**Double Mount Bracket**

|                 |                |                         |
|-----------------|----------------|-------------------------|
| Available Sizes | 48" x 14"      | Ring Spacing 30" (± ½") |
|                 | Material       | Steel                   |
|                 | Finish         | Black Powder Coated     |
| Style           | Squared Spiral |                         |
| Duty            | Heavy          |                         |

**Hardware**

Item # **SBH**



**Galvanized Steel Rubber Coated Sign Hanging Hardware**

|                 |                     |        |
|-----------------|---------------------|--------|
| Available Sizes | 1/4"                | SBH025 |
|                 | 3/8"                | SBH038 |
|                 | 1/2"                | SBH050 |
| Material        | Steel               |        |
| Finish          | Black Rubber Coated |        |
| Hole Size       | 9/32"               |        |
| Sold as         | Pair                |        |

Item # **SBH-SH150**



**Black Powder Coated S Hooks**

|          |                     |
|----------|---------------------|
| Length   | 1 ½"                |
| Diameter | 3/16"               |
| Material | Steel               |
| Finish   | Black Powder Coated |
| Sold as  | Pair                |



## Pre-Cut Sign Blanks



**Kong Aluminum sign blank for outdoor wayfinding, directionals and site markers.**

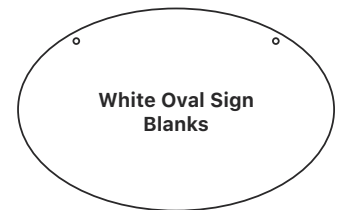
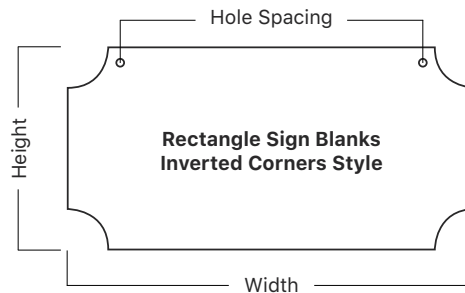

- Sign blanks are White/White (front/back)
- Two 5/16" diameter holes at the top allow for hanging from sign brackets or hooks.

## White Rectangle Sign Blanks Inverted Corners Style

| Dimensions | Thickness | Hole Spacing | Material | Duty   | Item #               |
|------------|-----------|--------------|----------|--------|----------------------|
| 18" x 6"   | 0.025"    | 8"           | Aluminum | Light  | APCB18-06-063-2P-WIC |
| 10" x 6"   | 0.063"    | 6"           | Aluminum | Medium | APCB10-06-063-2P-WIC |
| 14" x 7"   |           | 10"          |          |        | APCB14-07-063-2P-WIC |
| 18" x 6"   |           | 8"           |          |        | APCB18-06-063-2P-WIC |
| 20" x 10"  | 0.080"    | 14"          | Aluminum | Heavy  | APCB20-10-063-2P-WIC |
| 22" x 12"  |           | 14"          |          |        | APCB22-12-063-2P-WIC |
| 34" x 14"  | 0.080"    | 22"          | Aluminum | Heavy  | APCB34-14-080-2P-WIC |
| 44" x 16"  |           | 30"          |          |        | APCB44-16-080-2P-WIC |

## White Oval Sign Blanks

| Dimensions | Thickness | Material |          | Duty  | Item #              |
|------------|-----------|----------|----------|-------|---------------------|
| 16" x 11"  | 0.080"    | 10"      | Aluminum | Heavy | APCB16-11-080-2P-WO |
| 22" x 14"  |           | 14"      |          |       | APCB22-14-080-2P-WO |
| 33" x 22"  |           | 22"      |          |       | APCB33-22-080-2P-WO |
| 46" x 30"  |           | 30"      |          |       | APCB46-30-080-2P-WO |

Corrugated Boards



High Quality polypropylene corrugated board, treated with corona on both sides for printing purposes.



- Moisture and water resistant
- Easy to cut and print on
- Cost-effective

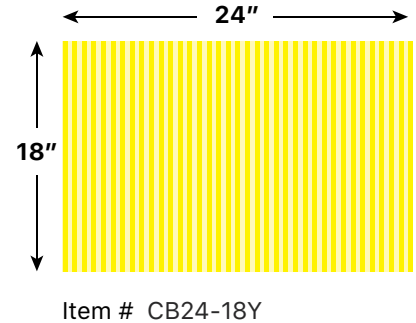
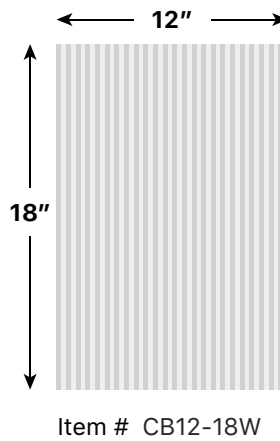

\* Flutes run vertically

White Corrugated Plastic Board

| Width | Height | Thickness | Color | Item #   |
|-------|--------|-----------|-------|----------|
| 12"   | 18"    | 4mm       | White | CB12-18W |
| 18"   | 12"    |           |       | CB18-12W |
| 18"   | 24"    |           |       | CB18-24W |
| 24"   | 18"    |           |       | CB24-18W |
| 24"   | 24"    |           |       | CB24-24W |
| 24"   | 36"    |           |       | CB24-36W |
| 36"   | 24"    |           |       | CB36-24W |

Yellow Corrugated Plastic Board

| Width | Height | Thickness | Color  | Item #   |
|-------|--------|-----------|--------|----------|
| 18"   | 24"    | 4mm       | Yellow | CB18-24Y |
| 24"   | 18"    |           |        | CB24-18Y |





## Foam Boards



**Premium White and Black Foam Board Sheets High-Density Professional Use, Perfect for Presentations, Signboards, Arts and Crafts, Framing, Display.**

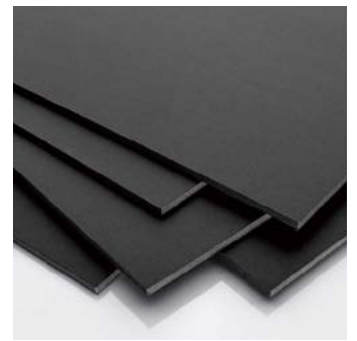
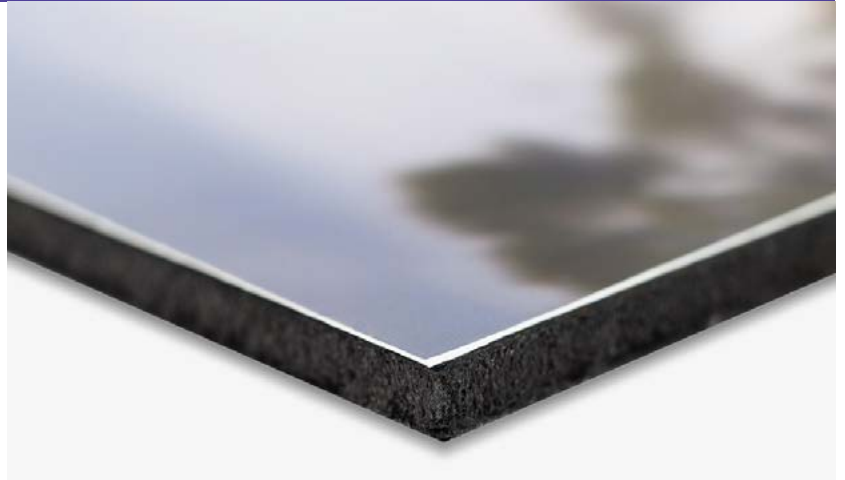

## White Foam Board Sheets

| Dimensions | Thickness | Color   | Duty        | Item #         |
|------------|-----------|---|-------------|----------------|
| 48" x 96"  | .050      | Double Sided White Coated Board               | Light Duty  | NP9810-4896M   |
| 48" x 96"  | 1/2"      | White Face, Black Core, Black Face            |             | FC9210-4896WBB |
| 36" x 48"  | 3/16"     | White Insight Board                           |             | FC9120-3648W   |
| 40" x 60"  | 3/16"     | White Foam Board                              |             | FC9150-4060W   |
| 40" x 60"  | 3/16"     | White Quik Step Board (Single Sided Adhesive) |             | FC9160-4060W   |
| 48" x 96"  | 3/16"     | White Foam Board                              |             | FC9270-4896W   |
| 48" x 96"  | 1/2"      | White Foam Board                              |             | FC9275-4896W   |
| 48" x 96"  | 1/4"      | White Mighty Core Board (Extra Rigid)         | Medium Duty | FC9300-4896W   |
|            | 1/2"      | White Mighty Core Board (Extra Rigid)         |             | FC9310-4896W   |
|            | 1/4"      | Bright White Mighty Core Board (Extra Rigid)  |             | FC9380-4896W   |
|            | 1/4"      | Gloss White Mighty Core Board (Extra Rigid)   |             | FC9400-4896GL  |
|            | .040      | White Vinyl Styrene Plastic Sheet             |             | FC9520-4896W   |

## Black Foam Board Sheets

| Dimensions | Thickness | Color                                 | Duty        | Item #       |
|------------|-----------|---------------------------------------|-------------|--------------|
| 48" x 96"  | 3/16"     | Black Ultra Mount Board               | Light Duty  | FC9001-4896B |
|            | 3/16"     | Black Foam Board                      |             | FC9250-4896B |
|            | 1/2"      | Black Foam Board                      |             | FC9260-4896B |
|            | 1/4"      | Black Mighty Core Board (Extra Rigid) | Medium Duty | FC9330-4896B |
|            | 1/2"      | Black Mighty Core Board (Extra Rigid) |             | FC9340-4896B |



*Reduce Picker  
Travel Time by  
up to 80%*

## **EZ-RACK Floor Roller Rack**

Better Way to Organize  
Your Vinyl

- Easy to Maneuver
- Heavy Duty Caster Wheels
- Powder-coated Steel
- Space Saving Design
- 2 Year Warranty



### **EZM12**

12 Roller Rack

Length | 23"

Height | 15"

Core | 2"

Max. Weight: 600 Lbs

**EZ-RACK Floor Roller Rack**



**EZM16-2**

16 Roller Rack

Length | 23 1/4"  
 Height | 22"  
 Core | 2"  
 Max. Weight: 1200 lbs



**EZM16-3**

16 Roller Rack

Length | 29-1/2"  
 Height | 22"  
 Core | 3"  
 Max. Weight: 1200 lbs



**EZH17**

17 Roller Rack

Length | 72-7/16"  
 Height | 58-1/16"  
 Core | 2" or 3"  
 Max. Weight: 1000 lbs

**EZH36**

36 Roller Rack

Length | 73 1/4"  
 Height | 39 3/8"  
 Core | 2" or 3"  
 Max. Weight: 1000 lbs



**WS-0101**  
 3" Diameter Vinyl Wrap Sheet Clip Storage Tool

**WS-0102**  
 4" Diameter Vinyl Wrap Sheet Clip Storage Tool

Economic Roll-Up



Suitable for; trade show, seminars, presentations, promotions, conferences, local fairs, exhibitions, retail stores, etc.

Our economy model is perfect for the client on a budget. A nice quality stand at a great price. Attached with 2-sided tape at the bottom and a top clamp bar. Includes a travel bag. The viewable height is 77"



**ERU800**  
Economic Roll-Up

\* Sold without design and graphic material



## Great way to get your brand noticed in busy settings!

- Quick & easy setup
- Indoor & outdoor material available
- Economy & Luxury styles

|                 |                |                 |         |
|-----------------|----------------|-----------------|---------|
| Silver Aluminum | Width: 31 1/2" | Height: 78 3/4" | ERU800  |
| Silver Aluminum | Width: 33 1/2" | Height: 78 3/4" | ERU850  |
| Silver Aluminum | Width: 39 1/2" | Height: 78 3/4" | ERU1000 |

Economic Roll-Up

# Economic Roll-Up



## ERU800

### Economic Roll Up

Width: 31 1/2"  
Height: 78 3/4"

Our economy model is perfect for the client on a budget. A nice quality stand at a great price. Attached with 2-sided tape at the bottom and a top clamp bar. Includes a travel bag. The viewable height is 77".



**Digital Banners & Films**  
available in Digital Media Tab



\* What's included

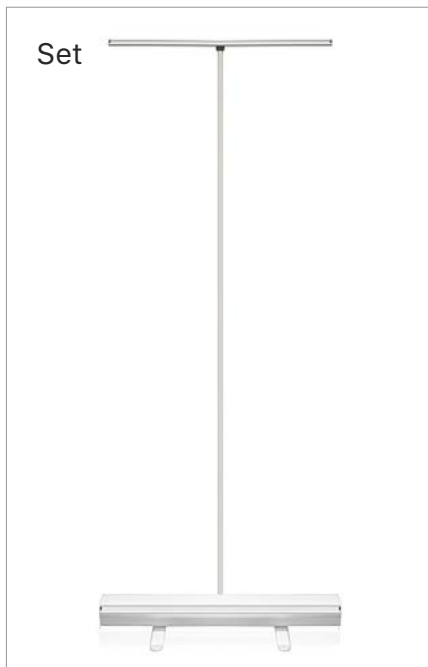

Set



Panel Bar



Base



Pole



Carry Bag



Economic Roll-Up



Our luxury model is a great looking, yet affordable stand. The flat base has adjustable feet that ensures a straight graphic. Attached with a 2-sided tape at the bottom and a top clamp bar. Includes a padded travel bag. Viewable height is 79".



**LRU800**  
Luxury Roll-Up

\* Sold without design and graphic material

\* What's included

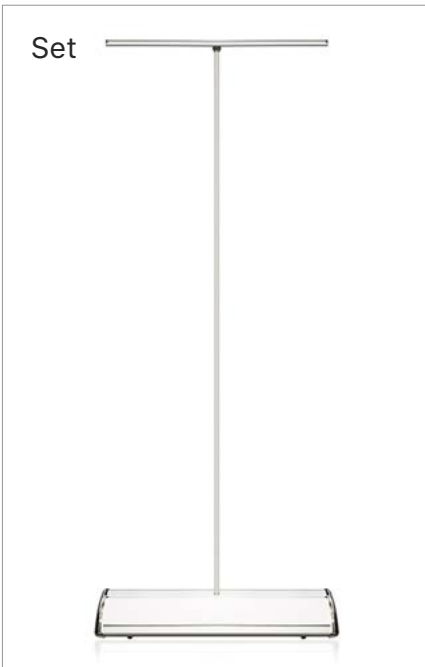

Set



Panel Bar



Base



Pole



Carry Bag

|                 |                |                 |         |
|-----------------|----------------|-----------------|---------|
| Silver Aluminum | Width: 31 1/2" | Height: 78 3/4" | LRU800  |
| Silver Aluminum | Width: 33 1/2" | Height: 78 3/4" | LRU850  |
| Silver Aluminum | Width: 39 1/2" | Height: 78 3/4" | LRU1000 |



**Digital Banners & Films**  
available in Digital Media Tab



Double L Standing Base



**Double L Standing Sign Base**

Base 14" x 16"  
 Height 4"  
 Material Steel

Set up a single or double-sided display with our easy-to-use Standing Sign Base and make an impression wherever you set it up.

**Item # PS370**

\* Sold without design and graphic material

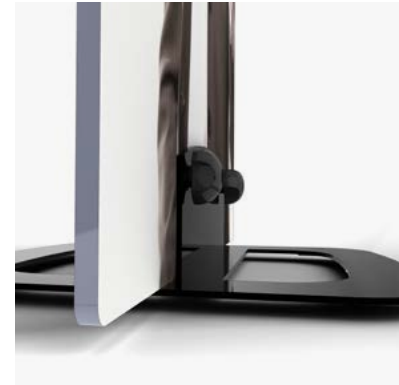

Tripod Banner Stand

Tripod Banner Stand



**Tripod Banner Stand**

Width 23 5/8"  
 Height 63"  
 Carrying Case Yes

This travel friendly full-size tripod provides stable support for grommeted banners. Silver finish. Includes carrying case

**Item # TB600**

\* Sold without design and graphic material

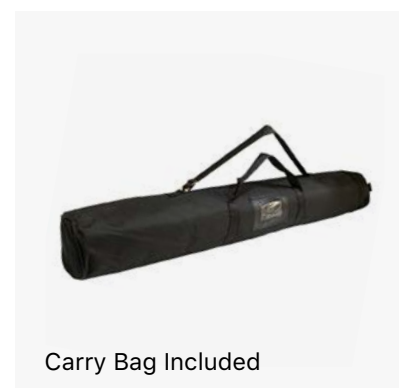

Carry Bag Included



**MBS  
SIGNSUPPLY**

*Milano*

**DIGITAL  
PAPERS & FILMS**

**Daily Pickup and 1 or 2 Days Ground Shipping to Most of the States**



**Mbs-Standoffs &  
Mbs-Signsupply  
Headquarters  
TAMPA**



**Mbs-Standoffs &  
Mbs-Signsupply  
CHICAGO**



**Mbs-Standoffs &  
Mbs-Signsupply  
Milano  
DENVER**



**Mbs-Standoffs &  
Mbs-Signsupply  
LAS VEGAS**

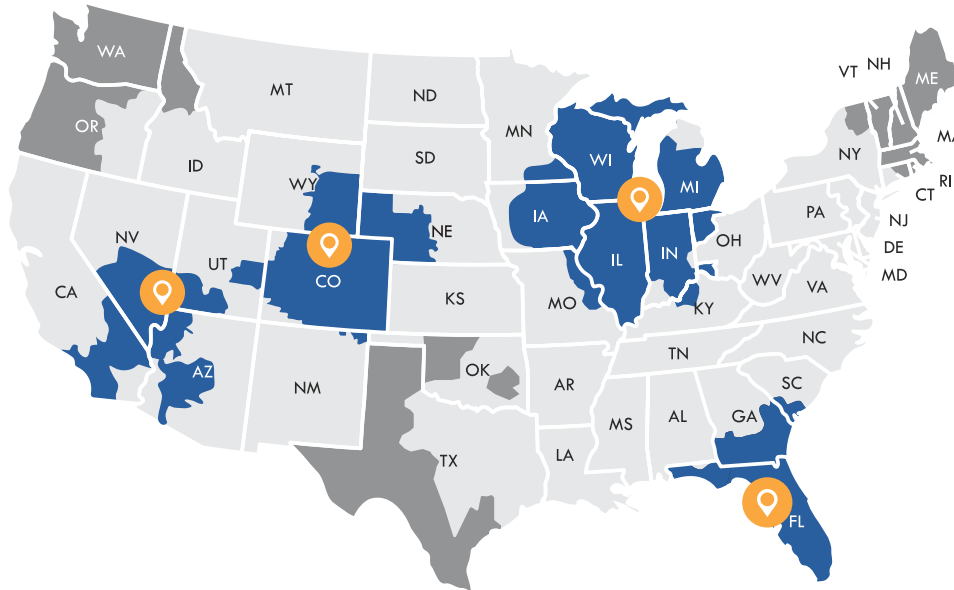

Receive in 1 Day



Receive in 2 Days



Receive in 3 Days



**HQ Tampa**  
5046 W Linebaugh Ave.  
Tampa, FL 33624  
+1 (303) 935-8565

**Chicago**  
941 Enterprise Ct.  
St. Charles, IL 60174  
+1 (917) 728-1182

**Las Vegas**  
8375 Eastgate Rd.  
Henderson, NV 89015  
+1 (213) 769-4010

*Milano*  
Digital Papers & Films

**Denver**  
7084 S. Revere Pkwy.  
Centennial, CO 80112  
+1 (303) 935-8565

For more information, call +1 (303) 935-8565 or See our website [mbs-signsupply.com](http://mbs-signsupply.com)